

Cancio

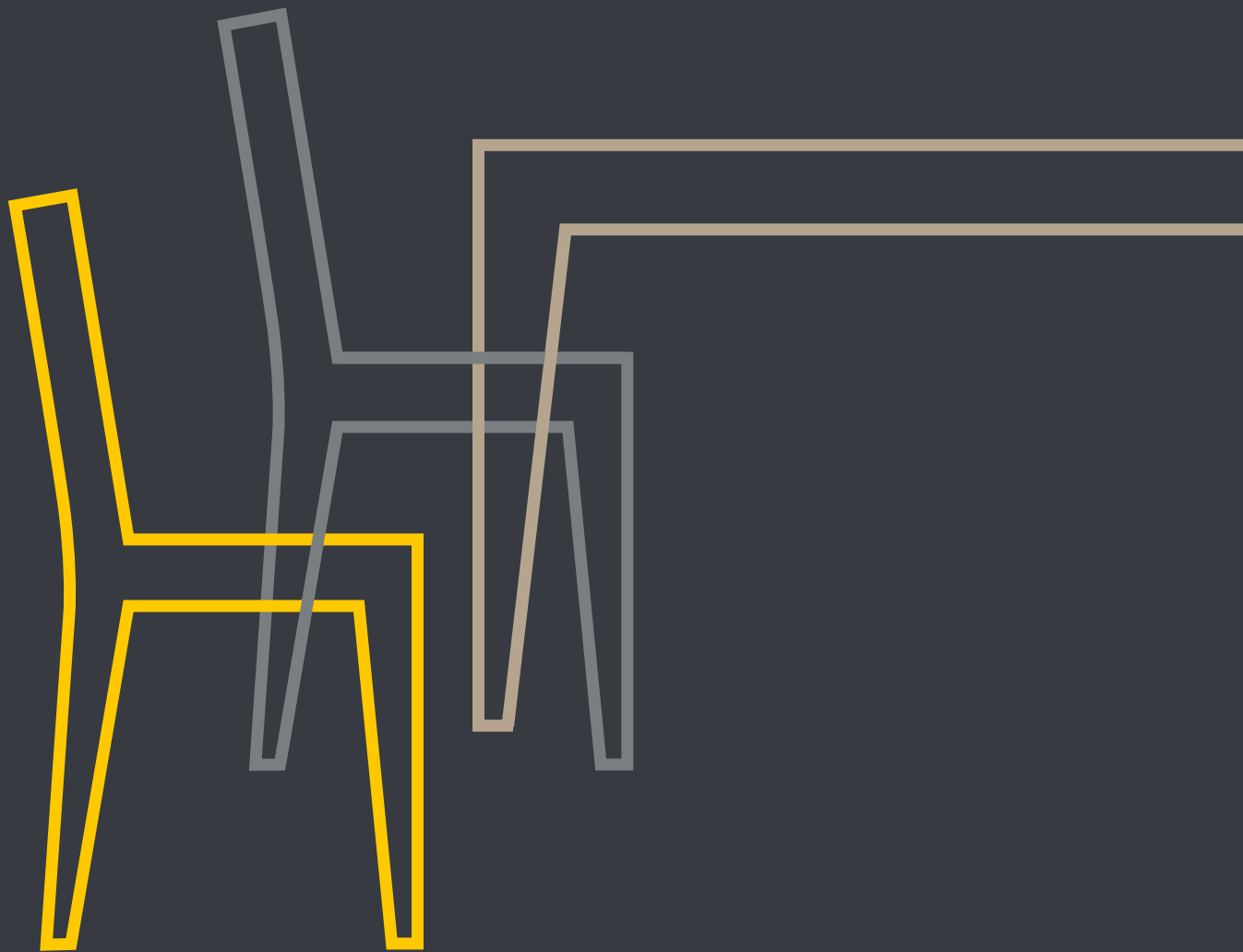

MESAS Y SILLAS
PARA LA COCINA

11

TABLES AND CHAIRS FOR THE KITCHEN
TABLES ET CHAISES DE CUISINE
MESAS E CADEIRAS PARA A COZINHA



CATÁLOGO GENERAL / GENERAL CATALOGUE / CATALOGUE GÉNÉRAL / CATÁLOGO GERAL

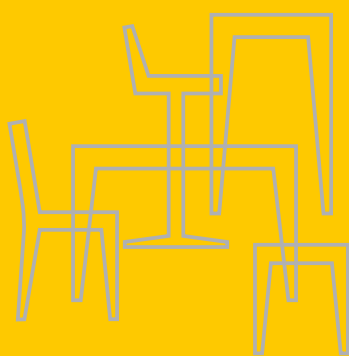

Barras / Bars / Barres / Barras

80	Modelo Model Modèle Modelo	Página Page Page Página	Extensiones Extensions Rallonges Extensiones	Medida mesa abierta Table open measure Dimension table ouverte Medida mesa abierta
80 ø	Star bar	26	-	-
80x65	Mercury	6	-	-

110

110x40	Cumbre	22	-	-
110x70	Concept	16	2	144x70 / 178x70

120

120x65	Coloritta	12	-	-
120x65	Mercury	6	-	-
120x80	Coloritta	12	-	-
120x80	Concept	16	2	159x80 / 198x80
120x80	Mercury	6	-	-

160

160x40	Cumbre	22	-	-
160x65	Coloritta	12	-	-
160x65	Mercury	6	-	-
160x80	Coloritta	12	-	-
160x80	Mercury	6	-	-

Mesas / Tables / Tables / Mesas

70	Modelo Model Modèle Modelo	Página Page Page Página	Extensiones Extensions Rallonges Extensiones	Medida mesa abierta Table open measure Dimension table ouverte Medida mesa abierta
75x70	Bambola	70	2	104x70 / 133x70

80

80x52	Bambola minor	76	2	80x68,5 / 80x85
-------	---------------	----	---	-----------------

90

90 ø	Star	100	-	-
90x52	Concept minor	66	1	90x80
90x55	Logic	92	-	-

100

100x50	Bambola minor	76	2	100x66,5 / 100x83
100x60	Bambola	70	2	129x60 / 158x60
100x60	Camel	44	2	129x60 / 158x60
100x60	Fusion	96	2	129x60 / 158x60
100x60	Logic	92	-	-
100x60	Oceanmetal	88	2	130x60 / 160x60
100x60	Zeta	84	1	145x60
100x60	Zetaplancha	104	-	-

110

110x70	Bambola	70	2	139x70 / 168x70
110x70	Camel	44	2	139x70 / 168x70
110x70	Capuccina	80	1	155x70
110x70	Concept	61	2	144x70 / 178x70
110x70	Fusion	96	2	139x70 / 168x70
110x70	Logic	92	-	-
110x70	Zeta	84	1	155x70
110x70	Zetaplancha	104	-	-
115x52	Concept minor	66	1	115x80
115x65	Camel	44	2	144x65 / 173x65
115x65	Logic	92	-	-
115x70	Oceanmetal	88	2	145x70 / 175x70
115x70	Rizzo	54	2	149x70 / 183x70

120

120x65	Coloritta	40	-	-
120x70	Logic	92	-	-
120x80	Coloritta	40	-	-
120x80	Concept	61	2	159x80 / 198x80
125x80	Bambola	70	2	154x80 / 183x80
125x80	Camel	44	2	154x80 / 183x80
125x80	Fusion	96	2	154x80 / 183x80
125x80	Logic	92	-	-
125x80	Rizzo	54	2	164x80 / 203x80

130

130x75	Ducal	106	-	-
130x80	Capuccina	80	1	175x80

160

160x65	Coloritta	40	-	-
160x80	Atika	50	-	-
160x80	Bambola	70	2	189x80 / 218x80
160x80	Coloritta	40	-	-
160x80	Ducal	106	-	-
160x90	Concept	61	2	199x90 / 238x90
160x90	Logic	92	-	-



Producto a medida
Custom-made product
Produit sur mesure
Prodotto à medida

Barras / Bars / Barres / Barras

B	Modelo Model Modèle Modelo	Página Page Page Página	Extensiones Extensions Rallonges Extensiones
-	Multipla	30	2

Mesas / Tables / Tables / Mesas

M	Modelo Model Modèle Modelo	Página Page Page Página	Extensiones Extensions Rallonges Extensiones
-	Multipla	36	2

Barras / Bars / Barres / Barras



Mesas / Tables / Tables / Mesas



Taburetes bar / Bar stools / Tabourets bar / Bancos bar

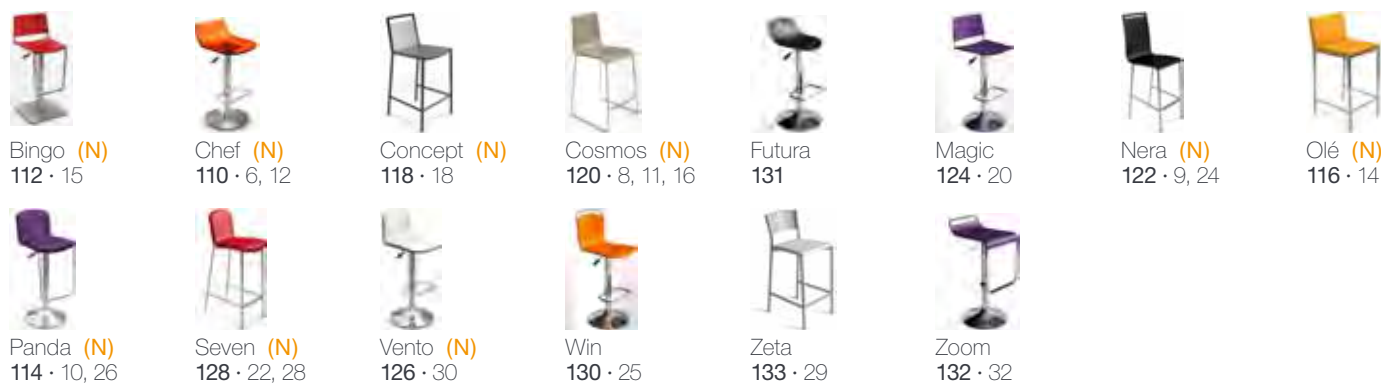

Sillas / Chairs / Chaises / Cadeiras



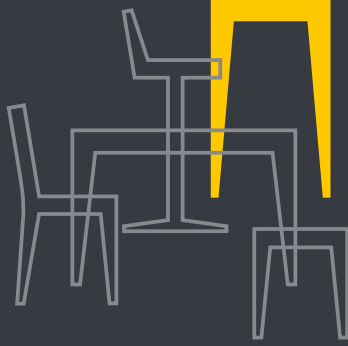



Mercury



mercury

6

Mercury ▯

Encimera porcelánico basalto.
Basalt porcelain worktop.
Plateau céramique basalte.
Tampo cerâmico basalto.

Chef I

Asiento policarbonato transparente.
Transparent polycarbonate seat.
Assise polycarbonate transparent.
Assento policarbonato transparente.



Mercury



8

Mercury

Encimera cristal negro mate.

Matt black glass worktop.

Plateau verre noir mat.

Tampo vidro preto mate.

Cosmos

Asiento lacado negro.

Black lacquered seat.

Assise laqué noir.

Assento lacado preto.



Mercury Π

Encimera porcelánico nieve.

Snow porcelain worktop.

Plateau céramique neige.

Tampo cerâmico neve.

Nera I

Asiento lacado antracita.

Anthracite lacquered seat.

Assise laqué Anthracite.

Assento lacado antracite.



Sistema de anclaje a la pared mediante escuadra metálica.

Wall anchorage system by framing bracket.

Système d'ancrage sur le mur moyennant équerre métallique.

Sistema de fixação à parede mediante escuadra metálica.

Mercury

Mercury ▯

Encimera cristal rojo brillo.
Glossy red glass worktop.
Plateau verre rouge brillant.
Tampo vidro vermelho brilho.

Panda I

Asiento lacado rojo.
Red lacquered seat.
Assise laqué rouge.
Assento lacado vermelho.



10

Imagen superior. Barra en posición plegada.
Picture above. Bar in folded position.
Image supérieur. Bar en position plié.
Imagem superior. Barra em posição fechada.

Imagen derecha. Barra en posición desplegada.
Picture on the right. Bar in unfolded position.
Image droit. Bar en position déplié.
Imagem direita. Barra em posição aberta.



Sistema de deslizamiento sobre la encimera.
Gliding system on worktop.
Système de glissement sur le plateau.
Sistema de deslizamento sobre tampo.



Juego de ruedas en la pata.
Set of wheels inside the leg.
Jeu de roulettes dans le pied.
Jogo de rodas na perna.

Altura adaptable en plazos de entrega estándar.

Adaptable height on standard delivery times.

Hauteur adaptable dans délais de livraison standard.

Altura adaptável nos prazos de entrega standard.



Altura a medida
Custom-made height
Hauteur sur mesure
Altura à medida



■ Mercury

80x65 · 120x65 · 120x80 · 160x65 · 160x80

Coloritta



12



Coloritta 

Encimera porcelánico nieve.

Snow porcelain worktop.

Plateau céramique neige.

Tampo cerâmico neve.

Chef 

Asiento policarbonato fumé.

Fumé polycarbonate seat.

Assise polycarbonate fumé.

Assento policarbonato fumé.



Coloritta

Coloritta Π

Todocolor blanco.

White Todocolor.

Todocolor blanc.

Todocolor branco.

Olé Ξ

Asiento y respaldo foam confort Nobel Negro.

Black Nobel foam comfort seat and back.

Assise et dossier foam confort Nobel noir.

Assento e encosto foam confort Nobel preto.



15

Coloritta

Encimera cristal gris metalizado brillo.
Glossy metallised grey glass worktop.
Plateau verre gris métallisé brillant.
Tampo vidro cinzento metalizado brilho.

Bingo

Asiento y respaldo lacado fucsia.
Fuchsia lacquered seat and back.
Assise et dossier laqué fuchsia.
Assento e encosto lacado fucsia.

Coloritta

120x65 · 120x80 · 160x65 · 160x80

Concept





Concept **Π**

Encimera cristal moka brillo.
Glossy mocha glass worktop.
Plateau verre moka brillant.
Tampo vidro moka brilho.

Cosmos **I**

Asiento lacado moka.
Mocha lacquered seat.
Assise laqué moka.
Assento lacado moka.

Concept porcelánico



Encimera porcelánico

Porcelain worktop.

Plateau céramique.

Tampo cerâmico.



Impermeable
Non absorbent
Imperméable
Impermeável



Resistente al fuego y al calor
Fire proof and heat resistant
Résistante au feu et à la chaleur
Resistente ao fogo e calor



Colores inalterables
Fast to light colours
Couleurs inaltérables
Cores inalteráveis



Resistente a productos químicos
Chemical resistant
Résistance aux produits chimiques
Resistente a produtos químicos



Superficie higiénica
Hygienic surface
Surface hygiénique
Superfície higiênica



Resistente a los rayones
Scratch resistant
Rien ne peut la rayer
Resistência a riscos

18

Concept

Encimera porcelánico cemento.
Cement colour porcelain worktop.
Plateau céramique ciment.
Tampo cerâmico cimento.

Concept

Asiento y respaldo lacado negro.
Black lacquered seat and back.
Assise et dossier laqué noir.
Assento e encosto lacado preto.





Concept



20



Concept ▮

Encimera cristal blanco brillo.

Glossy white glass worktop.

Plateau verre blanc brillant.

Tampo vidro branco brilho.

Magic I

Asiento y respaldo lacado blanco.

White lacquered seat and back.

Assise et dossier laqué blanc.

Assento e encosto lacado branco.



Ampliación mediante una o dos alas a juego con la encimera principal.
Enlargement by one or two wings, matching the main worktop.
Agrandissement moyennant un ou deux ailes à jeu avec le plateau principal.
Ampliação mediante uma ou duas extensões a jogo com o tampo principal.

21

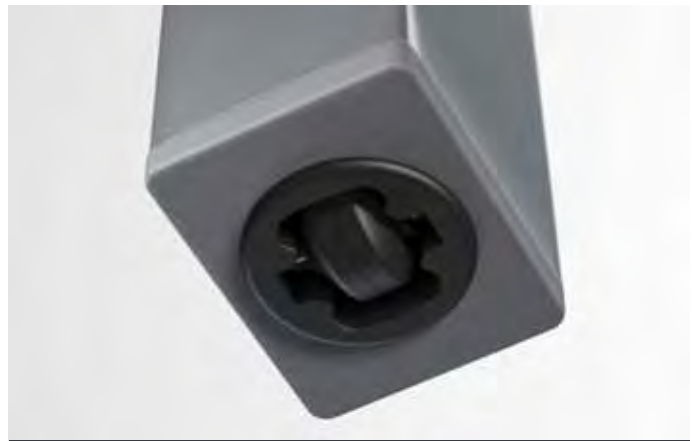

Juego de ruedas en las patas.
Set of wheels inside the legs.
Jeu de roulettes dans le pied.
Jogo de rodas nas pernas.

■ **Concept**

110x70 · 120x80

Cumbre



Cumbre ▮

Encimera cristal tórtola mate.

Matt turtledove glass worktop.

Plateau verre tourterelle mat.

Tampo vidro tortola mate.

Seven †

Asiento lacado tórtola.

Turtledove lacquered seat.

Assise laqué tourterelle.

Assento lacado tortola.



Cumbre

Cumbre ▯

Encimera cristal rojo brillo.
Glossy red glass worktop.
Plateau verre rouge brillant.
Tampo vidro vermelho brilho.

Nera I

Asiento lacado rojo.
Red lacquered seat.
Assise laqué rouge.
Assento lacado vermelho.





25

Cumbre

Encimera cristal negro brillo.

Glossy black glass worktop.

Plateau verre noir brillant.

Tampo vidro preto brilho.

Win

Asiento lacado negro.

Black lacquered seat.

Assise laqué noir.

Assento lacado preto.

Cumbre

110x40 · 160x40

Star bar





Star bar Π

Encimera cristal gris metalizado brillo.
Glossy metallised grey glass worktop.
Plateau verre gris métallisé brillant.
Tampo vidro cinzento metalizado brilho.

Panda I

Asiento foam confort Nobel violeta.
Violet foam comfort Nobel seat.
Assise foam confort Nobel violet.
Assento foam confort Nobel violeta.

Star bar



Star bar Π

Encimera cristal negro mate.

Matt black glass worktop.

Plateau verre noir mat.

Tampo vidro preto mate.

Seven I

Asiento foam confort Nobel negro.

Black foam comfort Nobel seat.

Assise foam confort Nobel noir.

Assento foam confort Nobel preto.





Star bar Π

Encimera cristal blanco brillo.

Glossy white glass worktop.

Plateau verre blanc brillant.

Tampo vidro branco brilho.

Zeta Γ

Asiento foam confort Kanon verde.

Green foam comfort Kanon seat.

Assise foam confort Kanon vert.

Assento foam confort Kanon verde.

■ Star bar

80 ø

Barra Multipla



Ahora también extensible.

Now, also extensible.

Maintenant aussi extensible.

Agora também extensível.





Producto a medida
Custom-made product
Produit sur mesure
Produto à medida



31

Multipla

Encimera cristal tórtola brillo.
Glossy turtledove glass worktop.
Plateau verre tourterelle brillant.
Tampo vidro tortola brilho.

Vento

Asiento tapizado foam confort Nobel tórtola.
Turtledove foam comfort Nobel upholstered seat.
Assise recouvert foam confort Nobel tourterelle.
Assento estofado foam confort Nobel tortola.

Barra Multipla

32

Multipla

Encimera cristal negro brillo. Ruedas en las patas.
Glossy black glass worktop. Wheeled legs.
Plateau verre noir brillant. Roulettes dans le pied.
Tampo vidro preto brilho. Rodas nas pernas.

Zoom

Asiento lacado negro.
Black lacquered seat.
Assise laqué noir.
Assento lacado preto.

Multipla, la barra a medida.

Multipla, the custom-made bar.

Multipla, le bar sur mesure.

Multipla, a barra à medida.

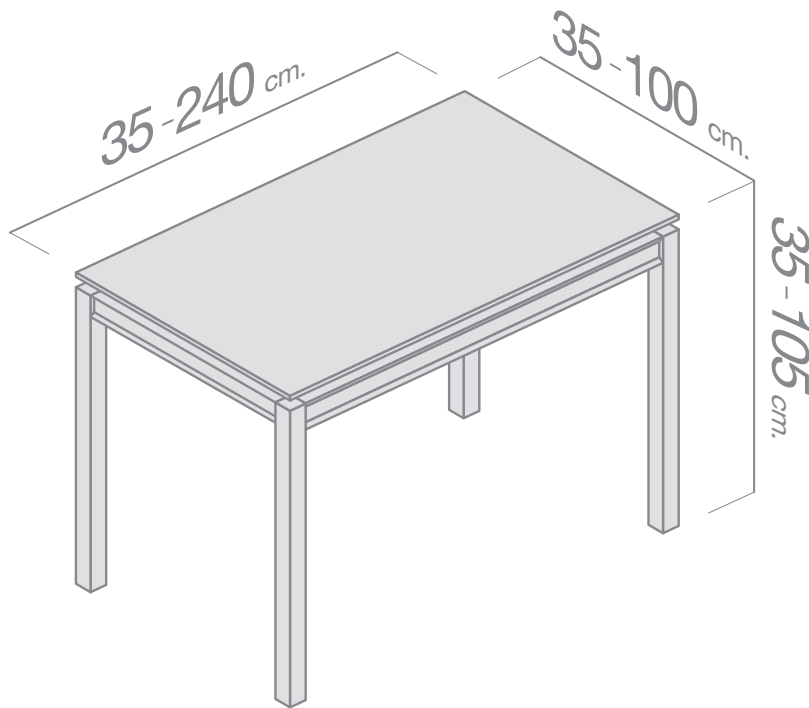

Puede elegir cualquier tamaño entre 35 y 240 cm. de largo, 35 y 100 cm. de ancho y hasta 105 cm. de alto.

Está disponible con encimera laminada, de cristal, o sin encimera.

Además puede ser fija o llevar dos alas extensibles, de 30 centímetros cada una, en la opción cristal. Tiene la opción de llevar ruedas en las patas.

You can choose every size: length between 35 and 240cm, width between 35 and 100cm and height up to 105 cm. It is available with laminated worktop, glass worktop or without any worktop. In addition, it can be fixed or have two extendible wings, 30 cm each, in glass option. Optionally, it can be made with wheeled feet.

Vous pouvez choisir tout dimensions entre; une longueur entre 35 et 240 cm., une largeur entre 35 et 100 cm., et une hauteur jusqu'à 105 cm. C'est disponible avec plateau laminé, verre ou sans plateau. En plus il peut être fixe ou avoir deux ailes extensibles, de 30 cm. chaqu'une, avec l'option verre. Il y a l'option d'avoir roulettes dans le pied.

Pode escolher qualquer tamanho entre 35 y 240 cm de largura e até 105 cm de comprimento. Disponível com tampo laminado, de vidro ou sem tampo. Fixa ou com dois extensíveis de 30 cm, na opção vidro. Opção de rodas nas pernas.

33



Opción encimera laminada.
Option laminated worktop.
Option plateau laminé.
Opção tampo laminado.



Opción encimera de cristal.
Option glass worktop.
Option plateau de verre.
Opção tampo vidro.



Opción sin encimera.
Option without any worktop.
Option sans plateau.
Opção sem tampo.



Opción ruedas en las patas.
Option wheeled legs.
Option roulettes dans le pied.
Opção rodas nas pernas.

Calcula tu presupuesto on line en: / *Calculate your online quotation on:*

Calculez votre devis en ligne à: / Calcula o teu orçamento online em:

www.canciomuebles.com





Multipla extensible



Producto a medida
Custom-made product
Produit sur mesure
Produto à medida

Ahora también extensible.

Now, also extensible.

Maintenant aussi extensible.

Agora também extensível.





37

Multipla

Encimera cristal gris metalizado brillo.
Glossy metallised grey glass worktop.
Plateau verre gris métallisé brillant.
Tampo vidro cinzento metalizado brilho.

Concept

Asiento tapizado Kanon azafrán.
Saffron Kanon upholstered seat.
Assise recouvert Kanon safran.
Assento estofado kanon açafão.

Multipla contract



38

Multipla

Encimera cristal hielo mate.
Matt ice glass worktop.
Plateau verre blanc mat.
Tampo vidro gelo mate.

Multipla

Asiento laminado blanco.
White laminated seat.
Assise laminé blanc.
Assento laminado branco.

Multipla, la mesa a medida.

Multipla, the custom-made table.

Multipla, le table sur mesure.

Multipla, a mesa à medida.

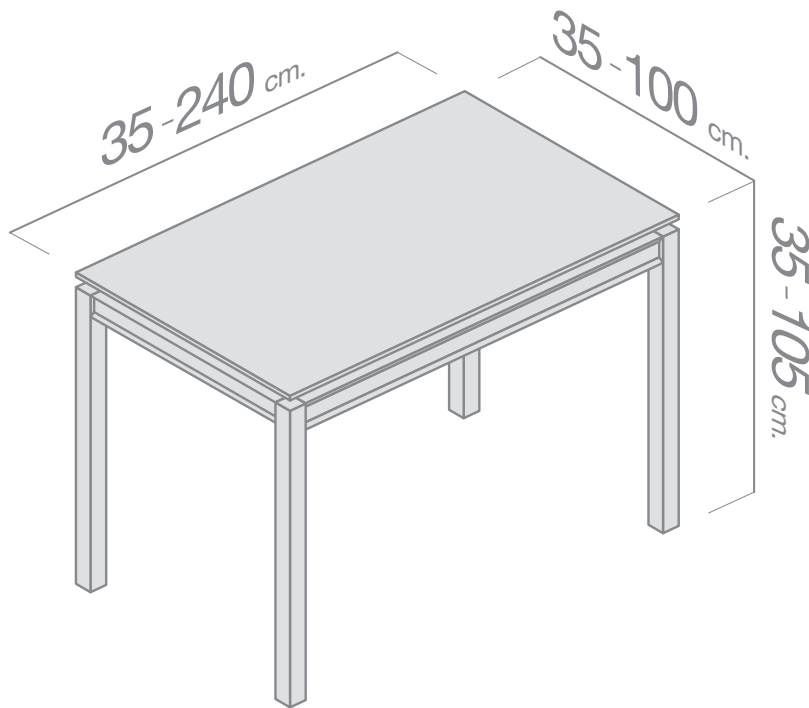

Puede elegir cualquier tamaño entre 35 y 240 cm. de largo, 35 y 100 cm. de ancho y hasta 105 cm. de alto.

Está disponible con encimera laminada, de cristal, o sin encimera.

Además puede ser fija o llevar dos alas extensibles, de 30 centímetros cada una, en la opción cristal. Tiene la opción de llevar ruedas en las patas.

You can choose every size: length between 35 and 240cm, width between 35 and 100cm and height up to 105 cm. It is available with laminated worktop, glass worktop or without any worktop. In addition, it can be fixed or have two extendible wings, 30 cm each, in glass option. Optionally, it can be made with wheeled feet.

Vous pouvez choisir tout dimensions entre; une longueur entre 35 et 240 cm., une largeur entre 35 et 100 cm., et une hauteur jusqu'à 105 cm. C'est disponible avec plateau laminé, verre ou sans plateau. En plus il peut être fixe ou avoir deux ailes extensibles, de 30 cm. chaqu'une, avec l'option verre. Il y a l'option d'avoir roulettes dans le pied.

Pode escolher qualquer tamanho entre 35 y 240 cm de largura e até 105 cm de comprimento. Disponível com tampo laminado, de vidro ou sem tampo. Fixa ou com dois extensíveis de 30 cm, na opção vidro. Opção de rodas nas pernas.

39



Opción encimera laminada.
Option laminated worktop.
Option plateau laminé.
Opção tampo laminado.



Opción encimera de cristal.
Option glass worktop.
Option plateau de verre.
Opção tampo vidro.



Opción sin encimera.
Option without any worktop.
Option sans plateau.
Opção sem tampo.



Opción ruedas en las patas.
Option wheeled legs.
Option roulettes dans le pied.
Opção rodas nas pernas.

Calcula tu presupuesto on line en: / *Calculate your online quotation on:*

Calculez votre devis en ligne à: / Calcula o teu orçamento online em:

www.canciomuebles.com

Coloritta



Coloritta

Encimera cristal gris metalizado brillo.
Glossy metallised grey glass worktop.
Plateau verre gris métallisé brillant.
Tampo vidro cinzento metalizado brilho.

Olé

Asiento y respaldo tapizado foam confort Kanon carbón.
Coal Kanon foam comfort upholstered seat and back.
Assise et dossier recouvert foam confort Kanon charbon.
Assento e encosto estofado foam confort Kanon carvão.



Coloritta



42



Coloritta

Encimera cristal blanco brillo.
Glossy white glass worktop.
Plateau verre blanc brillant.
Tampo vidro branco brilho.

Eros

Asiento/respaldo blanco.
White seat/back.
Assise/dossier blanc.
Assento/encosto branco.

Coloritta 

Todocolor negro.

Black Todocolor.

Todocolor noir.

Todocolor preto.

Fantasy 

Asiento policarbonato fumé.

Fumé polycarbonate seat.

Assise polycarbonate fumé.

Assento policarbonato fumé.

 Coloritta

120x65 · 120x80 · 160x65 · 160x80



Camel

44

Camel

Encimera compacto blanco.

White compact worktop.

Plateau compact blanc.

Tampo compacto branco.

Spirit

Asiento tapizado foam confort Square plata.

Silver square foam confort upholstered seat.

Assise recouvert foam confort Square argent.

Assento estofado foam confort Square prata.





Camel

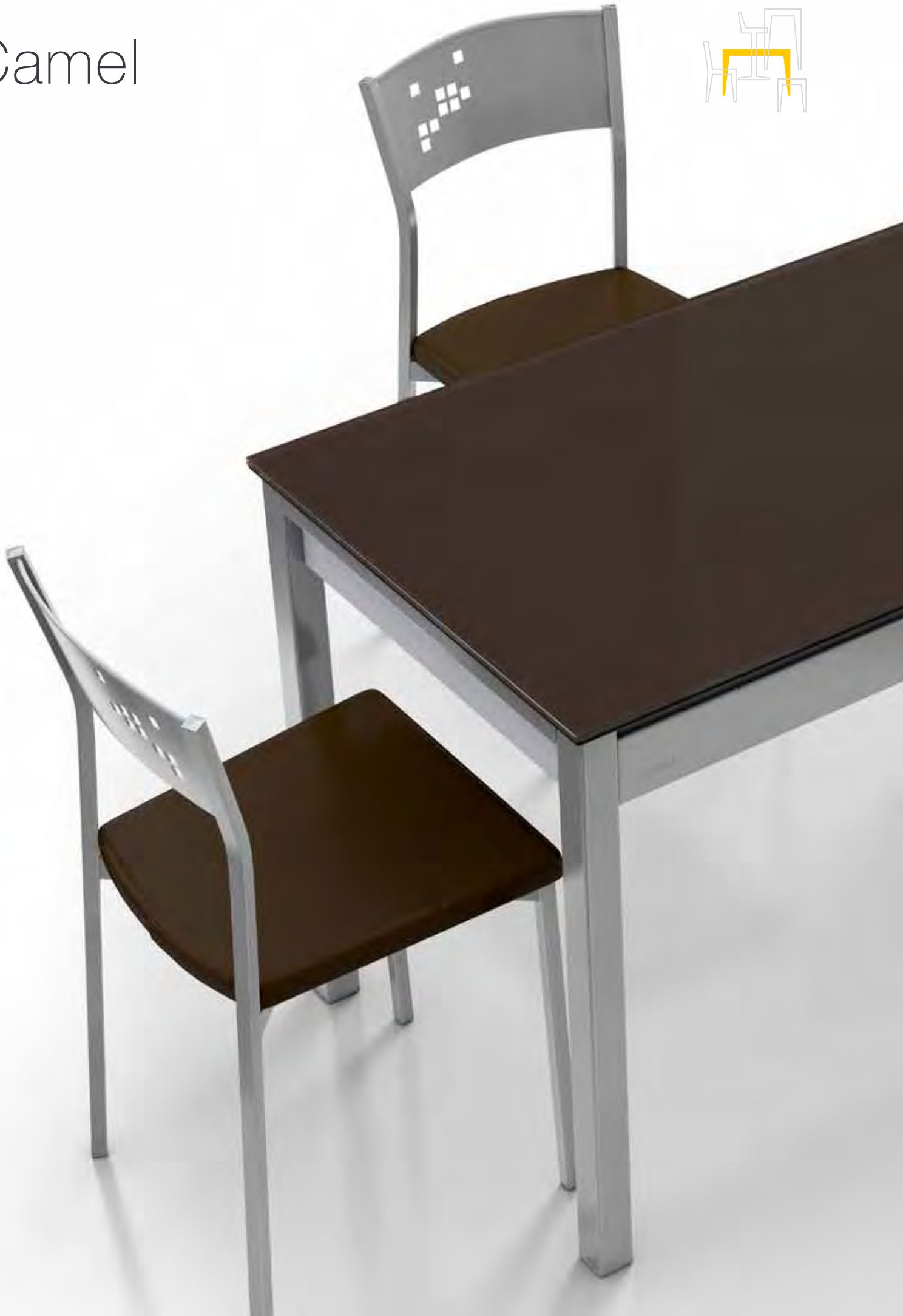

Camel 

Encimera cristal moka brillo.

Glossy mocha glass worktop.

Plateau verre moka brillant.

Tampo vidro moka brilho.

Zeta 

Asiento tapizado foam confort Nobel moka.

Mocha Nobel foam confort upholstered seat.

Assise recouvert foam confort Nobel moka.

Assento estofado foam confort Nobel moka.



Camel



48

Camel

Encimera cristal rojo brillo.
Glossy red glass worktop.
Plateau verre rouge brillant.
Tampo vidro vermelho brilho.

Oceanmetal

Asiento laminado rojo.
Red laminated seat.
Assise laminé rouge.
Assento laminado vermelho.



Encimera ampliable mediante dos alas laterales.
Worktop enlargement by two lateral wings.
Plateau extensible avec deux rallonges.
Tampo ampliável mediante duas extensões laterais.



Cajón de gran capacidad con mecanismo de freno.
High capacity drawer, with brake system.
Tiroir de grand capacité avec mécanisme de frein.
Gaveta de grande capacidade, com mecanismo de freio.

■ Camel

100x60 · 110x70 · 115x65 · 125x80

Atika



50



Atika

Encimera porcelánico Basalto.

Basalt porcelain worktop.

Plateau céramique basalto.

Tampo cerâmico basalto.

Fantasy

Asiento policarbonato transparente.

Transparent polycarbonate seat.

Assise polycarbonate transparent.

Assento policarbonato transparente.



Atika





53

Atika

Encimera porcelánico nieve.

Snow porcelain worktop.

Plateau céramique neige.

Tampo cerâmico neve.

Olé

Asiento y respaldo foam confort Kanon verde.

Green foam comfort Kanon seat and back.

Assise et dossier foam confort Kanon vert.

Assento e encosto foam confort Kanon verde.

■ Atika

160x80

Rizzo extensible





Rizzo 

Encimera cristal hielo mate.
Matt ice glass worktop.
Plateau verre blanc mat.
Tampo vidro gelo mate.

Comet 

Asiento y respaldo blanco.
White seat and back.
Assise et dossier blanc.
Assento e encosto branco.

Rizzo metallic top



56

Rizzo

Encimera acero vitrificado tórtola.

Vitrified steel turtledove worktop.

Plateau acier vitrifié tourterelle.

Tampo aço vitrificado tortola.

Eclipse

Lacado negro.

Black lacquered.

Laqué noir.

Lacado preto.

Encimera acero vitrificado

Vitrified steel worktop

Plateau acier vitrifié

Tampo aço vitrificado



Sin uniones
Without joints
Sans joints
Sem uniões



Superficie higiénica
Hygienic surface
Surface hygiénique
Superfície higiênica



Resistente al fuego y al calor
Fire proof and heat resistant
Résistante au feu et à la chaleur
Resistente ao fogo e calor



Tacto texturizado
Textured touch
Toucher texturé
Tato texturizado



Resistente a los rayones
Scratch resistant
Rien ne peut la rayer
Resistência a riscos



Rizzo





Ampliación mediante una o dos alas de apertura automática.
Enlargement by one or two wings with automatic opening.
Extension par une ou deux rallonges d'ouverture automatique.
Ampliação mediante um o dois extensíveis de abertura automática.

59

Rizzo

Encimera cristal negro brillo.
Glossy black glass worktop.
Plateau verre noir brillant.
Tampo vidro preto brilho.

Mystic

Policarbonato transparente.
Transparent polycarbonate.
Polycarbonate transparent.
Policarbonato transparente.

■ Rizzo

115x70 · 125x80

Concept

60

Concept

Encimera compacto blanco.

White compact worktop.

Plateau compact blanc.

Tampo compacto branco.

Spirit

Asiento foam confort Kanon púrpura.

Purple foam comfort Kanon seat.

Assise foam confort Kanon pourpre.

Assento foam confort kanon purpura.



Encimera compacto.

Compact worktop.

Plateau compact.

Tampo compacto.



Impermeable
Non absorbent
Imperméable
Impermeável



Superficie higiénica
Hygienic surface
Surface hygiénique
Superfície higiênica



Resistente al fuego y al calor
Fire proof and heat resistant
Résistante au feu et à la chaleur
Resistente ao fogo e calor



Resistente al impacto
Impact resistant
Résistant au impact
Resistente ao impacto



Resistente a productos químicos
Chemical resistant
Résistance aux produits chimiques
Resistente a produtos químicos



Colores inalterables
Fast to light colours
Couleurs inaltérables
Cores inalteráveis



Tacto cálido
Warm touch
Toucher chaud
Tato cálido

Nueva medida 160x90 cm.
New measure 160x90 cm.
Nouvelle mesure 160x90 cm.
Nova medida 160x90 cm.

Concept



62

Concept

Encimera porcelánico Basalto.

Basalt porcelain worktop.

Plateau céramique basalto.

Tampo cerâmico basalto.

Hot h

Asiento foam confort Kanon azafrán.

Saffron foam comfort Kanon seat.

Assise foam confort Kanon safran.

Assento foam confort Kanon açafão.

Encimera porcelánico

Porcelain worktop.

Plateau céramique.

Tampo cerâmico.



Impermeable
Non absorbent
Imperméable
Impermeável



Resistente al fuego y al calor
Fire proof and heat resistant
Résistante au feu et à la chaleur
Resistente ao fogo e calor



Colores inalterables
Fast to light colours
Couleurs inaltérables
Cores inalteráveis



Resistente a productos químicos
Chemical resistant
Résistance aux produits chimiques
Resistente a produtos químicos



Superficie higiénica
Hygienic surface
Surface hygiénique
Superfície higiênica



Resistente a los rayones
Scratch resistant
Rien ne peut la rayer
Resistência a riscos



Detalle encimera porcelánico.

Porcelaine surface worktop detail.

Détail plateau céramique.

Detalhe tampo cerâmico.

Concept



64

Concept

Encimera cristal negro brillo.

Glossy black glass worktop.

Plateau verre noir brillant.

Tampo vidro preto brilho.

Hot

Asiento lacado negro.

Black lacquered seat.

Assise laqué noir.

Assento lacado preto.



Ampliación mediante una o dos alas a juego con la encimera principal.
Enlargement by one or two wings, matching the main worktop.
Agrandissement moyennant un ou deux ailes à jeu avec le plateau principal.
Ampliação mediante uma ou duas extensões a jogo com o tampo principal.

65

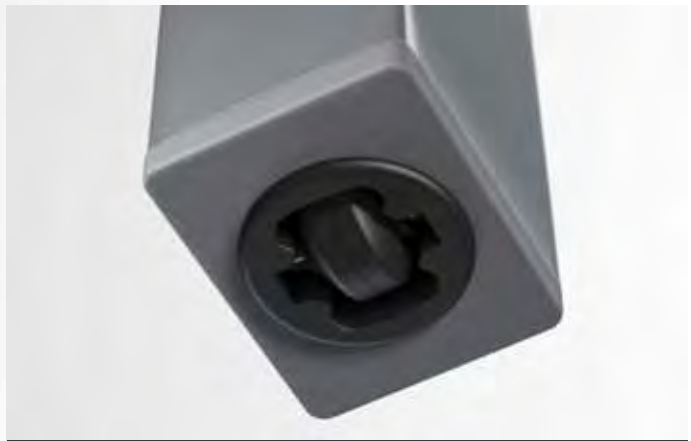

Juego de ruedas en las patas.
Set of wheels inside the legs.
Jeu de roulettes dans le pied.
Jogo de rodas nas pernas.

■ Concept

110x70 · 120x80 · 160x90

Concept minor





Concept minor 

Encimera cristal hielo mate.

Matt ice glass worktop.

Plateau verre blanc mat.

Tampo vidro gelo mate.

Nera 

Asiento lacado blanco.

White lacquered seat.

Assise laqué blanc.

Assento lacado branco.

Concept minor



Concept minor 

Encimera cristal rojo brillo.
Glossy red glass worktop.
Plateau verre rouge brillant.
Tampo vidro vermelho brilho.

Hot 

Asiento lacado rojo.
Red lacquered seat.
Assise laqué rouge.
Assento lacado vermelho.

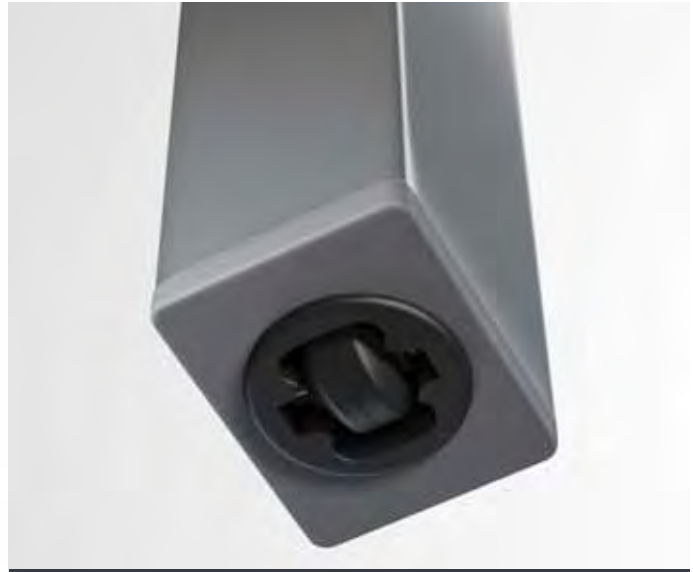

Juego de ruedas en las patas.
Set of wheels inside the legs.
Jeu de roulettes dans le pied.
Jogo de rodas nas pernas.



Mecanismo automático de apertura.
Automatic opening system.
Mécanisme automatique d'ouverture.
Mecanismo automático de abertura.

 **Concept minor**

90x52 · 115x52

Bambola



70

Bambola

Encimera cristal negro brillo.

Glossy black glass worktop.

Plateau verre noir brillant.

Tampo vidro preto brilho.

Concept

Asiento y respaldo lacado negro.

Black lacquered seat and back.

Assise et dossier laqué noir.

Assento e encosto lacado preto.



Bambola cromo



72

Bambola

Encimera cristal hielo mate. Armazón y patas cromadas.

Matt ice glass worktop. Chromed frame and legs.

Plateau verre glace mat. Armature et pied chromé.

Armação e pernas cromadas.

Yanky

Asiento policarbonato rojo.

Red polycarbonate seat.

Assise polycarbonate rouge.

Assento policarbonato vermelho.

Nueva medida 160x80 cm.

New measure 160x80 cm.

Nouvelle mesure 160x80 cm.

Nova medida 160x80 cm.

Encimera compacto.

Compact worktop.

Plateau compact.

Tampo compacto.



Bambola

Encimera compacto blanco.

White compact worktop.

Plateau compact blanc.

Tampo compacto branco.

Zeta

Asiento foam confort Kanon púrpura.

Purple foam comfort Kanon seat.

Assise foam confort Kanon pourpre.

Assento foam confort kanon purpura.

Bambola cuadro



Bambola

Encimera cristal negro mate.

Matt black glass worktop.

Plateau verre noir mat.

Tampo vidro preto mate.

Comet

Asiento y respaldo blanco.

White seat and back.

Assise et dossier blanc.

Assento e encosto branco.



Nueva medida 75x70 cm.
New measure 75x70 cm.
Nouvelle mesure 75x70 cm.
Nova medida 75x70 cm.



75



Detalle armazón aluminio listado.
Striped aluminium frame detail.
Détail armature aluminium listé.
Detalhe tampo alumínio listado.



Encimera ampliable mediante dos alas laterales a juego con la encimera.
Extensible worktop, by two side wings, matching the worktop.
Plateau extensible moyennant deux rallongues latérales à jeu avec le plateau.
Tampo ampliável mediante duas extensões laterais a jogo com o tampo.

■ Bambola

75x70 · 100x60 · 110x70 · 125x80 · 160x80

Bambola minor





Bambola minor 

Encimera cristal blanco brillo.

Glossy white glass worktop.

Plateau verre blanc brillant.

Tampo vidro branco brilho.

Nera 

Asiento lacado verde.

Green lacquered seat.

Assise laqué vert.

Assento lacado verde.



Bambola minor





Bambola minor

Encimera cristal tórtola mate.
Matt turtledove glass worktop.
Plateau verre tourterelle mat.
Tampo vidro tortola mate.

Spirit

Asiento lacado tórtola.
Turtledove lacquered seat.
Assise laqué tourterelle.
Assento lacado tortola.

Bambola minor

80x52 · 100x50

Capuccina

80



Capuccina 

Encimera Glasstone negro brillo.

Glossy black Glasstone worktop.

Plateau Glasstone noir brillant.

Tampo Glasstone preto brilho.

Mystic 

Policarbonato fumé.

Fumé polycarbonate.

Polycarbonate fumé.

Policarbonato fumé.



Capuccina



Capuccina

Encimera Glasstone gris metalizado brillo.
Glossy metallised grey Glasstone worktop.
Plateau Glasstone gris métallisé brillant.
Tampo Glasstone cinzento metalizado brilho.

On

Asiento y respaldo Net blanco.
White Net seat and back.
Assise et dossier Net blanc.
Assento e encosto Net branco.



Encimera Glasstone con canto biselado en curva.
Glasstone worktop, with beveled edge bend.
Plateau Glasstone avec chant biseautage courbé.
Tampo Glasstone com canto biselado em curva.



Rápido y sencillo sistema de extensión mediante un ala lateral.
Fast and easy extendable system, by a side wing.
Rapide et simple système d'extension moyennant un rallonge latéral.
Sistema de extensão rápida e fácil mediante uma extensão lateral.

■ Capuccina

110x70 · 130x80

Zeta

84

Zeta

Todocolor negro.

Black Todocolor.

Todocolor noir.

Todocolor preto.

Eros

Asiento amarillo.

Yellow seat.

Assise jaune.

Assento amarelo.





Zeta



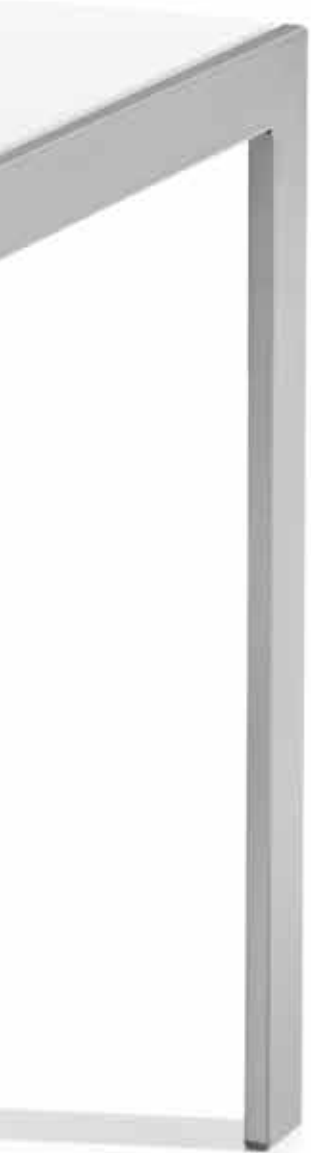

Extensión a juego con la encimera.
Extension matched with worktop.
Extension à jeu avec le plateau.
Extensão a jogo com o tampo.

87

Zeta

Encimera cristal hielo mate.
Matt ice glass worktop.
Plateau verre blanc mat.
Tampo vidro gelo mate.

Zeta

Asiento lacado antracita.
Anthracite lacquered seat.
Assise laqué Anthracite.
Assento lacado antracite.

Zeta

100x60 · 110x70

Oceanmetal





Oceanmetal 

Encimera cristal naranja brillo.
Glossy orange glass worktop.
Plateau verre orange brillant.
Tampo vidro laranja brilho.

Oceanmetal 

Asiento laminado naranja.
Orange laminated seat.
Assise laminé orange.
Assento laminado laranja.

Oceanmetal



90

Oceanmetal

Encimera laminado blanco.

White laminated worktop.

Plateau laminé blanc.

Tampo laminado branco.

Oceanmetal

Asiento laminado blanco.

White laminated seat.

Assise laminé blanc.

Assento laminado branco.



Encimera ampliable mediante dos alas laterales.
Worktop enlargement by two lateral wings.
Plateau extensible avec deux rallonges.
Tampo ampliável mediante duas extensões laterais.



Cajón cubertero de gran capacidad.
Cutlery drawer of a large capacity.
Tiroir à couverts de grand capacité.
Gaveta porta talheres de grande capacidade.

■ Oceanmetal

100x60 · 115x70

Logic





Logic 

Encimera cristal transparente mate.

Matt transparent glass worktop.

Plateau verre transparent mat.

Tampo vidro transparente mate.

Yanky 

Asiento policarbonato azul.

Blue polycarbonate seat.

Assise polycarbonate bleu.

Assento policarbonato azul.

Logic





Logic

Encimera cristal gris metalizado brillo.
Glossy metallised grey glass worktop.
Plateau verre gris métallisé brillant.
Tampo vidro cinzento metalizado brilho.

Noel

Asiento lacado fucsia.
Fuchsia lacquered seat.
Assise laqué fuchsia.
Assento lacado fucsia.

Logic

90x55 · 100x60 · 110x70 · 115x65 ·
120x70 · 125x80 · 160x90

Fusion light



96

Fusion

Encimera cristal blanco brillo. Base haya blanqueada.

Glossy white glass worktop. Bleached beech base.

Plateau verre blanc brillant. Bas hêtre blanchi.

Tampo vidro branco brilho. Base faia branqueada.

Eclipse

Asiento lacado blanco. Base haya blanqueada.

White lacquered seat. Bleached beech base.

Assise laqué blanc. Bas hêtre blanchi.

Assento lacado branco. Base faia branqueada.



Fusion



Fusion

Encimera negro brillo.

Glossy black glass worktop.

Plateau verre noir brillant.

Tampo vidro preto brilho.

Oceanmadera

Madera de haya teñida en wengué.

Dyeing wenge beech wood.

Bois d'hêtre teinté wengé.

Madeira de faia tingida wengue.



99

Encimera ampliable mediante dos alas laterales de cristal.

Extensible worktop by two side glass wings.

Plateau extensible moyennant deux rallonges latérales de verre.

Tampo ampliável mediante duas extensões de vidro.

Fusion

100x60 · 110x70 · 125x80

Star

100





Star 

Todocolor negro.
Black Todocolor.
Todocolor noir.
Todocolor preto.

Hot 

Asiento lacado blanco.
White lacquered seat.
Assise laqué blanc.
Assento lacado branco.

Star





Star 

Encimera cristal rojo brillo.
Glossy red glass worktop.
Plateau verre rouge brillant.
Tampo vidro vermelho brilho.

Comet 

Asiento y respaldo rojo.
Red seat and back.
Assise et dossier rouge.
Assento e encosto vermelho.

 Star

90 

Zetaplancha





Usar Zetaplancha es muy fácil.
Using Zetaplancha is very easy.
Utiliser zetaplancha c'est très facile.
Usar Zetaplancha é muito fácil.



Primero se liberan los seguros...
First of all, release the blocks...
D'abord on libère des sûretés...
Primeiro libertao se os seguros...



...y después se gira la encimera.
...and then, turn the worktop.
...et après on libère le plateau.
...e depois abate se o tampo.



Hay tres alturas de planchado.
There are three different ironing heights.
Il y a trois hauteurs de repassage.
Há três alturas de engomado.

Zetaplancha

Encimera cristal blanco brillo.
Glossy white glass worktop.
Plateau verre blanc brillant.
Tampo vidro branco brilho.

Astro

Asiento tapizado Kanon carbón.
Coal Kanon upholstered seat.
Assise recouvert Kanon charbon.
Assento estofado Kanon carvão.

Zetaplancha

100x60 · 110x70

Ducal





Ducal 

Acabado anticato.
Anticato finish.
Finition anticato.
Acabamento anticato.

Ducal 

Acabado anticato.
Anticato finish.
Finition anticato.
Acabamento anticato.

 Ducal

130x75 · 160x80



TABURETES BAR / *BAR STOOLS*
TABOURETS BAR / *BANCOS BAR*



Chef





Chef

Asiento policarbonato coloreado. Columna cromada. Base acero inoxidable.

Coloured polycarbonate seat. Chromed column. Stainless steel base.

Assise polycarbonate coloriée. Colonne chromée. Base en acier inoxydable.

Assento policarbonato colorado. Coluna cromada. Base aço inoxidável.

Bingo



Bingo

Asiento y respaldo lacado. Columna cromada.
Base acero inoxidable.

*Lacquered seat and back. Chromed column.
Stainless steel base.*

*Assise et dossier laqué. Colonne chromée.
Base en acier inoxydable.*

*Assento e encosto lacado. Coluna cromada.
Base aço inoxidável.*



Panda





Panda

Asiento lacado o foam confort. Reposapiés, base y columna cromadas.
Lacquered or foam comfort seat. Chromed footrest, base and column.
Assise laqué ou foam confort. repose-pied, base et colonne chromées.
Assento lacado ou foam confort. Reposa pés, base e coluna cromadas.

Olé



116



Olé **I**

Asiento y respaldo foam confort.
Foam comfort seat and back.
Assise et dossier foam confort.
Assento e encosto foam confort.

Altura 65 y 80 cm.
Height 65 and 80 cm.
Hauteur 65 et 80 cm.
Altura 65 e 80 cm.

Concept



Altura 65 y 80 cm.
Height 65 and 80 cm.
Hauteur 65 et 80 cm.
Altura 65 e 80 cm.

Concept **I**

Asiento lacado o tapizado. Respaldo lacado. Base acero pintado o cromado.

Lacquered or upholstered seat. Lacquered back. Painted steel or chromed base.

Assise laqué ou recouvert. Dossier laqué. Base acier peint ou chromé.

Assento lacado ou estofado. Encosto lacado. Base aço pintado ou cromado.



Cosmos



120



Cosmos **I**

Asiento lacado. Base acero macizo pintado o cromado.

Lacquered seat. Solid painted or chromed steel base.

Assise laqué. Base acier massif peint ou chromée.

Assento lacado. Base aço maciço pintado ou cromado.



Nera



Nera I

Asiento lacado. Base acero pintado o cromado.

Lacquered seat. Painted or chromed steel base.

Assise laqué. Base acier peint ou chromée.

Assento lacado. Base aço pintado ou cromado.





Altura 65 y 80 cm.
Height 65 and 80 cm.
Hauteur 65 et 80 cm.
Altura 65 e 80 cm.

Magic





Magic **I**

Asiento y respaldo lacado. Base y columna cromadas.
Lacquered seat and back. Chromed column and base.
Assise et dossier laqué. Colonne et base chromée.
Assento e encosto lacado. Base e coluna cromadas.

Vento



126



Vento I

Asiento tapizado foam confort. Base y columna cromadas.
Foam comfort upholstered seat. Chromed column and base.
Assise recouvert foam confort. Colonne et base chromée.
Assento estofado foam confort. Base e coluna cromadas.



Seven





Seven **I**

Asiento foam confort o lacado.
Base acero pintado o cromado.

*Foam comfort or lacquered seat.
Painted or chromed steel base.*

*Assise foam confort ou laqué.
Base acier peint ou chromée.*

*Assento foam confort ou lacado.
Base aço pintado ou cromado.*

Altura 65 y 80 cm.
Height 65 and 80 cm.
Hauteur 65 et 80 cm.
Altura 65 e 80 cm.

Win



130

Win

Asiento lacado. Base y columna cromadas.
Lacquered seat. Chromed column and base.
Assise laqué. Colonne et base chromée.
Asiento lacado. Base e coluna cromadas

Futura



131

Futura

Asiento policarbonato coloreado.
Base y columna cromadas.

*Coloured polycarbonate seat.
Chromed steel base and column.*

*Assise polycarbonate coloriée.
Base et colonne chromées.*

*Assento policarbonato colorado.
Base e coluna cromadas.*

Zoom



132



Zoom I

Asiento lacado o cuero regenerado. Base y columna cromadas.
Lacquered or regenerated leather seat. Chromed base and column.
Assise laqué ou cuir regeneré. Base et colonne chromées.
Assento lacado ou pele regenerada. Base e coluna cromadas.

Zeta

Altura 65 y 80 cm.
Height 65 and 80 cm.
Hauteur 65 et 80 cm.
Altura 65 e 80 cm.



133

Zeta I

Asiento tapizado foam confort o lacado. Base acero pintado.
Foam confort or lacquered seat. Painted steel base.
Assise foam confort ou laqué. Base acier peint.
Assento foam confort ou lacado. Base aço pintado.

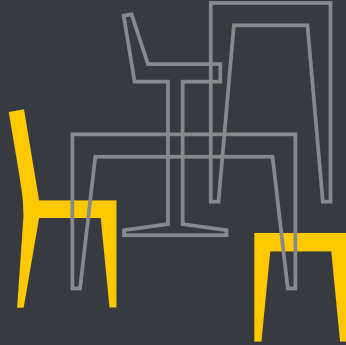



Yanky



136





137

Silla apilable.
Stackable chair.
Chaise empilable.
Cadeira apilhável.

Yanky **h**

Asiento policarbonato coloreado. Base acero pintado o cromado.
Coloured polycarbonate seat. Painted or chromed steel base.
Assise polycarbonate colorée. Base acier peint ou chromée.
Assento policarbonato colorado. Base aço pintado ou cromado.

Comet





Comet **h**

Asiento y respaldo resina sintética coloreada. Base acero pintado.

Coloured synthetic resin seat and back. Painted steel base.

Assise et dossier résine synthétique colorée. Base acier peint.

Assento e encosto resina sintética colorada. Base aço pintado.

Olé



140

Olé h

Asiento y respaldo foam confort. Base acero pintado o cromado.
Foam comfort seat and back. Painted or chromed steel base.
Assise et dossier foam confort. Base acier peint ou chromée.
Assento e encosto foam confort. Base aço pintado ou cromado.



Nera





Nera

Asiento lacado. Base acero pintado o cromado.

Lacquered seat. Painted or chromed steel base.

Assise laqué. Base acier peint ou chromée.

Assento lacado. Base aço pintado ou cromado.

Spirit





Spirit **hh**

Asiento tapizado foam confort o lacado. Base acero pintado.

Foam confort or lacquered seat. Painted steel base.

Assise foam confort ou laqué. Base acier peint.

Assento foam confort ou lacado. Base aço pintado.

Fantasy



146

Fantasy

Asiento policarbonato coloreado. Base haya blanqueada.
Coloured polycarbonate seat. Bleached beech base.
Assise polycarbonate colorée. Base hêtre blanchi.
Assento policarbonato colorado. Base faia branqueada.



Eros



148

Eros h

Asiento/respaldo resina sintética coloreada.
Base acero pintado o cromado.

*Coloured synthetic resin seat/back.
Painted or chromed steel base.*

*Assise/dossier résine synthétique colorée.
Base acier peint ou chromée.*

*Assento/encosto resina sintética colorada.
Base aço pintado ou cromado.*



Eclipse



Eclipse **h**

Asiento lacado. Base lacada o haya blanqueada.

Lacquered seat. Lacquered or bleached beech.

Assise laqué. Base laqué ou hêtre blanchi.

Assento lacado. Base lacada ou faia branqueada.



Hot foam confort



152

Hot h

Asiento foam confort. Base acero pintado o cromado.

Foam confort seat. Painted or chromed steel base.

Assise foam confort. Base acier peint ou chromée.

Assento foam confort. Base aço pintado ou cromado.

Hot



153

Hot **h**

Asiento lacado. Base acero pintado o cromado.
Lacquered seat. Painted or chromed steel base.
Assise laqué. Base acier peint ou chromée.
Assento lacado. Base aço pintado ou cromado.

Concept





155



Concept **h n**

Asiento y respaldo lacado. Base acero pintado o cromado.
Lacquered seat and back. Painted or chromed steel base.
Assise et dossier laqué. Base acier peint ou chromée.
Assento e encosto lacado. Base aço pintado ou cromado.

Mystic



Mystic h

Policarbonato coloreado.

Coloured polycarbonate.

Polycarbonate colorié.

Policarbonato colorado.



Zeta



157

Zeta **h n**

Asiento tapizado foam confort o lacado.
Base acero pintado.

*Foam confort or lacquered seat.
Painted steel base.*

*Assise foam confort ou laqué.
Base acier peint.*

*Assento foam confort ou lacado.
Base aço pintado.*

On



158



On **h**

Asiento y respaldo net. Base acero pintado.

Net seat and back. Painted steel base.

Assise et dossier net. Base acier peint.

Assento e encosto net. Base aço pintado.

Astro



159

Astro **h n**

Asiento lacado o tapizado. Base acero pintado.
Lacquered or upholstered seat. Painted steel base.
Assise laqué ou recouvert. Base acier peint.
Assento lacado ou estofado. Base aço pintado.

Oceanmetal

160



Oceanmetal h n

Asiento tapizado o laminado.
Base acero pintado.

*Upholstered or laminated seat.
Painted steel base.*

*Assise recouvert ou laminé.
Base acier peint.*

*Assento estofado ou laminado.
Base aço pintado.*

Noel



161

Noel ▣

Asiento lacado o tapizado. Base acero pintado.
Lacquered or upholstered seat. Painted steel base.
Assise laqué ou recouvert. Base acier peint.
Assento lacado ou estofado. Base aço pintado.

Pop



162



Pop

Resina sintética coloreada.
Coloured synthetic resin.
Résine synthétique colorée.
Resina sintética colorada.

Silla apilable.
Stackable chair.
Chaise empilable.
Cadeira apilhável.

Blu



163

Blu h

Asiento y respaldo net. Base acero pintado.

Net seat and back. Painted steel base.

Assise et dossier net. Base acier peint.

Assento e encosto net. Base aço pintado.

Silla plegable.

Folding chair.

Chaise pliante.

Cadeira plegável.

Oceanmadera



164

Oceanmadera

Madera maciza de haya.

Solid beech wood.

Bois massif d'hêtre.

Madeira maciça de faia.

Ducal



165

Ducal

Madera maciza de haya.

Solid beech wood.

Bois massif d'hêtre.

Madeira maciça de faia.

Seven



166



Seven ▣

Asiento lacado. Base acero pintado o cromado.

Lacquered seat. Painted or chromed steel base.

Assise laqué. Base acier peint ou chromée.

Assento lacado. Base aço pintado ou cromado.

Flash



167

Flash ▣

Asiento lacado o tapizado. Base acero cromado.
Lacquered or upholstered seat. Chromed steel base.
Assise laqué ou recouvert. Base acier chromée.
Assento lacado ou estofado. Base aço cromado.

Acabados / Finishes / Finitions / Acabamentos

Madera / Wood / Bois / Madeira



Haya blanqueada / Bleached beech /
Hêtre blanchi / Faia branqueada



Natural / Natural / Naturel / Natural



Cerezo / Cherry / Cerisier / Cerejeira



Wengué / Wenge / Wenge / Wengué

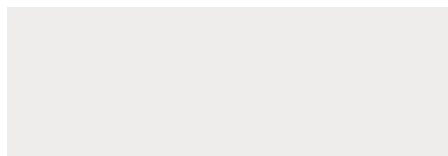

Anticato

Cristal mate / Matt glass / Verre mate / Vidro mate



Hielo / Ice / Glace / Gelo

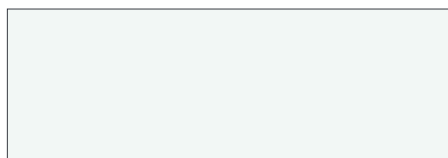

Transparente / Transparent / Transparent /
Transparente

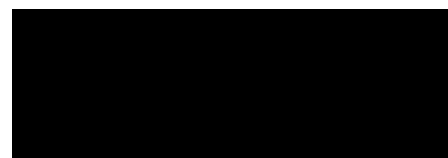

Negro / Black / Noir / Preto



Tórtola / Turtledove / Tourterelle / Tortola

Cristal brillo / Glossy glass / Verre brillant / Vidro brilho

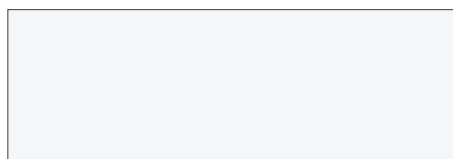

Blanco / White / Blanc / Branco



Extra blanco / Extra white / Extra blanc /
Extra branco

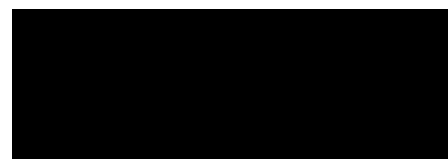

Negro / Black / Noir / Preto



Gris metalizado / Metallic grey / Gris métallisé
/ Cinzento metalizado



Naranja / Orange / Orange / Laranja



Rojo / Red / Rouge / Vermelho



Tórtola / Turtledove / Tourterelle / Tortola



Moka / Mocha / Moka / Moka

Porcelánico / *Porcelain / Céramique / Cerâmico*



Nieve / *Snow / Neige / Neve*



Cemento / *Cement / Ciment / Cimento*



Basalto / *Basalt / Basalte / Basalto*

Compacto / *Compact / Compact / Compacto*



Blanco / *White / Blanc / Branco*



Antracita / *Anthracite / Anthracite / Antracita*

Laminados / *Laminates / Laminés / Laminados*



Natural / *Natural / Naturel / Natural*



Cerezo / *Cherry / Cerisier / Cerejeira*



Wengué / *Wenge / Wenge / Wengué*



Blanco / *White / Blanc / Branco*



Gris metalizado / *Metallic grey / Gris métallisé / Cinzento metalizado*

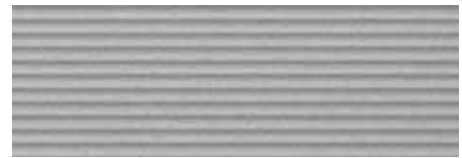

Aluminio listado / *Striped aluminium / Aluminium listé / Alumínio listado*



Cromado / *Chrome / Chromé / Cromado*



Naranja / *Orange / Orange / Laranja*



Verde / *Green / Vert / Verde*



Rojo / *Red / Rouge / Vermelho*



Tórtola / *Turtledove / Tourterelle / Tortola*



Moka / *Mocha / Moka / Moka*



Fucsia / *Fuchsia / Fuchsia / Fucsia*



Violeta / *Violet / Violet / Violeta*

Lacados / Lacquers / Laqués / Lacados



Blanco / White / Blanc / Branco

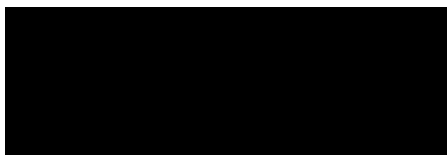

Negro / Black / Noir / Preto



Antracita / Anthracite / Anthracite / Antracita



Gris metalizado / Metallic grey / Gris métallisé / Cinzento metalizado



Naranja / Orange / Orange / Laranja



Verde / Green / Vert / Verde



Rojo / Red / Rouge / Vermelho



Tórtola / Turtledove / Tourterelle / Tortola



Moka / Mocha / Moka / Moka



Fucsia / Fuchsia / Fuchsia / Fucsia



Violeta / Violet / Violet / Violeta

170

Tapizados / Upholstery / Tapissés / Estofados



Vector gris / Grey Vector / Vector gris / Vector cinzento



Vector naranja / Orange Vector / Vector orange / Vector laranja



Vector verde / Green Vector / Vector vert / Vector verde



Vector rojo / Red Vector / Vector rouge / Vector vermelho

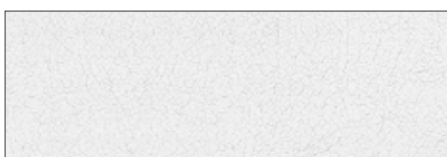

Nobel blanco / White Nobel / Nobel blanc / Nobel branco



Nobel negro / Black Nobel / Nobel noir / Nobel preto



Nobel gris / Grey Nobel / Nobel gris / Nobel cinzento



Nobel tórtola / Turtledove Nobel / Nobel tourterelle / Nobel tortola



Nobel moka / Mocha Nobel / Nobel moka / Nobel moka



Nobel fucsia / Fuchsia Nobel / Nobel fucsia / Nobel fucsia



Nobel violeta / Violet Nobel / Nobel violet / Nobel violeta

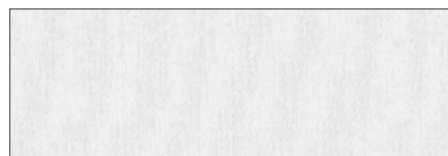

Kanon blanco / White Kanon / Kanon blanc / Kanon branco

Tapizados / Upholstery / Tapissés / Estofados



Kanon carbón / Coal Kanon / Kanon charbon / Kanon carvão



Kanon azafrán / Saffron Kanon / Kanon safran / Kanon açafraão



Kanon verde / Green Kanon / Kanon vert / Kanon verde



Kanon tórtola / Turtledove Kanon / Kanon tourterelle / Kanon tortola



Kanon púrpura / Purple Kanon / Kanon pourpre / Kanon purpura



Kanon azul / Blue Kanon / Kanon bleu / Kanon azul



Square plata / Silver Square / Square argent / Square prata



Cuero blanco / White leather / Cuir blanc / Pele branco

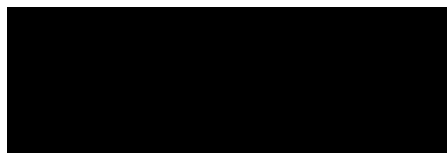

Cuero negro / Black leather / Cuir noir / Pele preto

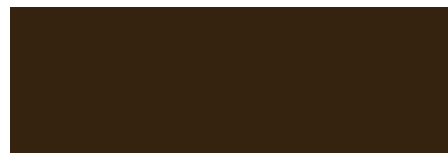

Cuero moka / Mocha leather / Cuir moka / Pele moka

Acero vitrificado / Vitrified steel / Acier vitrifié / Aço vitrificado



Acabado blanco / White finish / Finition blanc / Acabamento branco

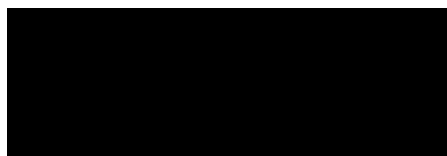

Acabado negro / Black finish / Finition noir / Acabamento preto



Acabado tórtola / Turtledove finish / Finition tourterelle / Acabamento tortola

Metal / Metal / Métal / Metal



Aluminio / Aluminium / Aluminium / Alumínio



Acabado aluminio / Aluminium finish / Finition aluminium / Acabamento alumínio



Cromado / Chrome / Chromé / Cromado



Acero inoxidable / Stainless steel / Acier inoxydable / Aço inoxidável



Acabado blanco / White finish / Finition blanc / Acabamento branco

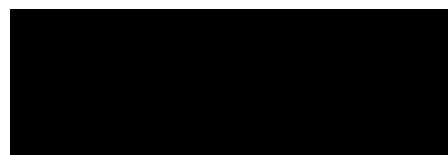

Acabado negro / Black finish / Finition noir / Acabamento preto



Acabado tórtola / Turtledove finish / Finition tourterelle / Acabamento tortola



comercial@canciomuebles.com
www.canciomuebles.com

Cancio



comercial@canciomuebles.com
www.canciomuebles.com