



TARIFA DE PRECIOS



Introducción

Frentes de puertas

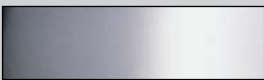
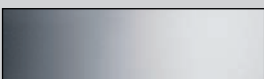
Los Hogares Spartherm ofrecen una amplia gama de acabados, desde los tradicionales totalmente funcionales hasta los más vanguardistas:

Para la serie: Prestige Linear Ambiente		S Estándar	Se trata de la gama convencional con los elementos de la puerta laqueados en negro y, refractarios, neutrales. La clásica imagen, fácil de limpiar y fácil de arreglar.
Para la serie: Prestige Linear		A Avantgarde (cromado brillante)	Hogar de diseño moderno con frente cromado (puerta y marco). Una imagen brillante, magnífica, totalmente resistente a la temperatura. Una verdadera alternativa.
Para la serie: Prestige Linear		AM Avantgarde-mate (cromado mate)	Hogar de diseño moderno con frente cromado mate (puerta y marco). La sobria y discreta elegancia de la construcción moderna.
Para la serie: Prestige Linear		VAG Acero fino pulido	Acero fino pulido: hogar de moderno diseño con un efecto mate del frente (puerta y marco). La sobria y discreta elegancia de la construcción moderna.

Conversión de los números de ensayos

Todos nuestros Hogares de chimenea para leña están ensayados bajo la norma DIN EN 13229, CE.

Ejemplo

Hogar	Altura de la puerta en cm	Estándar	Cromo		Acero fino pulido	Frentes de puertas	
			Brillo	Mate			
		S	A	AM	VAG		
Modelo	Mini R1V-4S		Serie - Linear*				
Puerta batiente	Batiente izquierda	51	1.625,-	1.878,-	1.878,-	Precio de tarifa sin IVA	
			S 1006835	A 1006831	AM 1006832		VAG 1006836
		57	1.738,-	2.000,-	2.000,-		Número de artículo
			S 1006792	A 1006843	AM 1006844		
Descripción del artículo	Batiente derecha	51	1.625,-	1.878,-	1.878,-	Observaciones especiales (marcado con )	
			S 1006841	A 1006837	AM 1006838		VAG 1006842
		57	1.738,-	2.000,-	2.000,-		
			S 1006799	A 1006795	AM 1006796		

* Modelos Linear



Cristal serigrafiado en los 4 lados con marco superior e inferior



Cristal serigrafiado a 3 lados sin marco en lado inferior

Mini



Hogar	Altura de la puerta en cm	Estándar	Cromo		Acero fino pulido
			Brillo	Mate	

S	A	AM	VAG
---	---	----	-----

Mini R1V-4S

LINEAR ^{4S}

	Batiente izquierda	51	1.625,-	1.878,-		1.878,-
			S 1006835	A 1006831	AM 1006832	VAG 1006836
		57	1.738,-	2.000,-		2.000,-
			S 1006792	A 1006843	AM 1006844	VAG 1006794

Potencia térmica nominal: Altura de la puerta 51 = 5,2 kW Altura de la puerta 57 = 5,0 kW Salida de humos: ø 160 mm Ancho de la puerta: 445 mm Funcionamiento de la puerta: Batiente 🔥 con autocierre	Batiente derecha	51	1.625,-	1.878,-		1.878,-
S 1006841			A 1006837	AM 1006838	VAG 1006842	
57		1.738,-	2.000,-		2.000,-	
		S 1006799	A 1006795	AM 1006796	VAG 1006800	

Mini R1Vh-4S

LINEAR ^{4S}

	Batiente inferior (para limpiar)	57,3	2.409,-	2.594,-		2.594,-
			S 1006817	A 1006813	AM 1006814	VAG 1006818

<input type="checkbox"/> Marcos remate obras, ahora en la página 37 Potencia térmica nominal: altura de puerta 57 = 5,0 kW Salida de humos: ø 160 mm Ancho de la puerta: 441 mm Funcionamiento de la puerta: Escamoteable 🔥 Marco presión
--



Mini

Hogar	Altura de la puerta en cm	Estándar	Cromo		Acero fino pulido
			Brillo	Mate	

S	A	AM	VAG
---	---	----	-----

Mini Z1-10,0 kW-4S

LINEAR

	Batiente izquierda	51	1.788,-	2.043,-		2.043,-
			S 1006855	A 1006847	AM 1006849	VAG 1006857
		57	1.920,-	2.184,-		2.184,-
			S 1006879	A 1006871	AM 1006873	VAG 1006881

Potencia térmica nominal: 10,0 kW Salida de humos: ø 180 mm Ancho de la puerta: 445 mm Funcionamiento de la puerta: Batiente con autocierre	Batiente derecha	51	1.788,-	2.043,-		2.043,-
S 1006867			A 1006859	AM 1006861	VAG 1006869	
57		1.920,-	2.184,-		2.184,-	
		S 1006892	A 1006884	AM 1006886	VAG 1006894	

Mini S-4S

LINEAR

	Batiente izquierda	51	1.705,-	2.317,-		2.317,-
			S 1012882	A 1012885	AM 1012886	VAG 1012887

Potencia térmica nominal: 7,0 kW Salida de humos: ø 180 mm Ancho de la puerta: 598 mm Funcionamiento de la puerta: Batiente con autocierre	Batiente derecha	51	1.705,-	2.317,-		2.317,-
S 1012888			A 1012891	AM 1012892	VAG 1012893	

Mini





Hogar	Altura de la puerta en cm	Estándar	Cromo		Acero fino pulido
			Brillo	Mate	

S	A	AM	VAG
---	---	----	-----



Mini Sh-4S

LINEAR 

	Batiente inferior (para limpiar)				
		51,3	2.296,-	2.907,-	2.907,-
		S 1000037	A 1003456	AM 1003457	VAG 1000036
<input type="checkbox"/> Marcos remate obras, ahora en la página 37 Potencia térmica nominal: 7,0 kW Salida de humos: ø 180 mm Ancho de la puerta: 606 mm Funcionamiento de la puerta: Escamoteable  Marco presión					

Mini Sh-3S

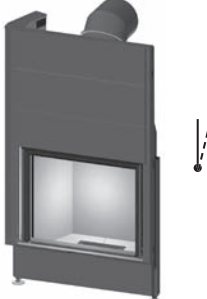
LINEAR 

	Batiente inferior (para limpiar)				
		48,3	2.296,-	-	-
		S 1011100	-	-	-
<input type="checkbox"/> Marcos remate obras, ahora en la página 37 Potencia térmica nominal: 7,0 kW Salida de humos: ø 180 mm Ancho de la puerta: 606 mm Funcionamiento de la puerta: Escamoteable  Marco presión					



Varia

Hogar	Altura de la puerta en cm	Estándar	Cromo		Acero fino pulido
			Brillo	Mate	

S	A	AM	VAG
---	---	----	-----

Varia 1V-4S

LINEAR ^{4S}

	Batiente izquierda	51	1.902,-	2.234,-		2.234,-
			S 1006978	A 1006974	AM 1006975	VAG 1006979
		57	2.029,-	2.360,-		2.360,-
			S 1006992	A 1006986	AM 1006987	VAG 1006993

<p>Potencia térmica nominal: 11,0 kW</p> <p>Salida de humos: ø 200 mm</p> <p>Ancho de la puerta: 668 mm</p> <p>Funcionamiento de la puerta: Batiente</p> <p>🔥 con autocierre</p>	Batiente derecha	51	1.902,-	2.234,-		2.234,-
			S 1006984	A 1006980	AM 1006981	VAG 1006985
		57	2.029,-	2.360,-		2.360,-
			S 1006998	A 1006994	AM 1006995	VAG 1006999

Varia 1Vh-4S

LINEAR ^{4S}

	Batiente inferior (para limpiar)	45,3	2.425,-	2.756,-		2.756,-
			S 1007004	A 1007000	AM 1007001	VAG 1007005
		51,3	2.549,-	2.882,-		2.882,-
			S 1007010	A 1007006	AM 1007007	VAG 1007011
		57,3	2.678,-	3.009,-		3.009,-
			S 1007016	A 1007012	AM 1007013	VAG 1007017

<input type="checkbox"/> Marcos remate obras, ahora en la página 38
Potencia térmica nominal: 11,0 kW
Salida de humos: ø 200 mm
Ancho de la puerta: 671 mm
Funcionamiento de la puerta: Escamoteable
🔥 Marco presión

Varia



Hogar	Altura de la puerta en cm	Estándar	Cromo		Acero fino pulido
			Brillo	Mate	

S	A	AM	VAG
---	---	----	-----

Varia 1Vh-3S

LINEAR 

	Batiente inferior (para limpiar)	44,3	2.425,-	-	-
			S 1007185	-	-
		50,3	2.549,-	-	-
			S 1007186	-	-
		56,3	2.678,-	-	-
			S 1007187	-	-

 Marcos remate obras, ahora en la página 38

Potencia térmica nominal: 11,0 kW

Salida de humos: ø 200 mm

Ancho de la puerta: 671 mm

Funcionamiento de la puerta: Escamoteable

 Marco presión

Varia Sh-4S

LINEAR 

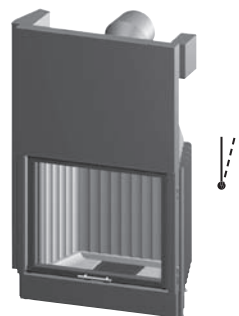
	Batiente inferior (para limpiar)				
		62,3	3.110,-	3.539,-	3.539,-
			S 1016330	A 1016333	AM 1016334

 Marcos remate obras, ahora en la página 38

Potencia térmica nominal: 11,0 kW

Salida de humos: ø 200 mm

Ancho de la puerta: 746 mm

Funcionamiento de la puerta: Escamoteable

 Marco presión





Varia

Hogar	Altura de la puerta en cm	Estándar	Cromo		Acero fino pulido
			Brillo	Mate	

S	A	AM	VAG
---	---	----	-----

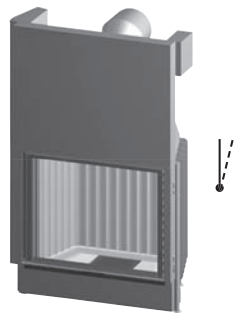

Varia Sh-3S

LINEAR 

	Battente inferior (para limpiar)				
		59,3	3.110,-	-	-
		S 1016336	-	-	-
<input type="checkbox"/> Marcos remate obras, ahora en la página 38 Potencia térmica nominal: 11,0 kW Salida de humos: ø 200 mm Ancho de la puerta: 746 mm Funcionamiento de la puerta: Escamoteable  Marco presión					

Varia ASH-4S-2

LINEAR 2 

	Battente inferior (para limpiar)				
		37	2.389,-	2.734,-	2.734,-
		S 1020172	A 1020175	AM 1020176	VAG 1020177
<input type="checkbox"/> Marcos remate obras, ahora en la página 38 Potencia térmica nominal: 7,0 kW Salida de humos: ø 180 mm Ancho de la puerta: 761 mm Funcionamiento de la puerta: Escamoteable  Linear 2da- Generación					

Varia





Hogar	Altura de la puerta en cm	Estándar	Cromo		Acero fino pulido
			Brillo	Mate	

S	A	AM	VAG
---	---	----	-----

Varia Ah-4S

LINEAR 

	Batiente inferior (para limpiar)				
		43,8	3.296,-	3.857,-	3.857,-
		S 1018550	A 1018553	AM 1018554	VAG 1018555

 Marcos remate obras, ahora en la página 38

Potencia térmica nominal: 10,4 kW
 Salida de humos: ø 200 mm
 Ancho de la puerta: 881 mm
 Funcionamiento de la puerta: Escamoteable
 Marco presión

Varia Ah-4S-2

LINEAR2 

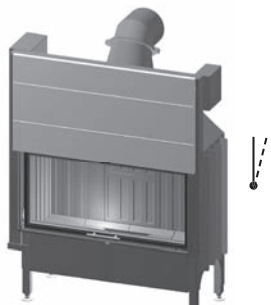
	Batiente inferior (para limpiar)				
		43	3.415,-	3.976,-	3.976,-
		S 1018252	A 1018253	AM 1018255	VAG 1018257

 Marcos remate obras, ahora en la página 38

Potencia térmica nominal: 9,0 kW
 Salida de humos: ø 200 mm
 Ancho de la puerta: 867 mm
 Funcionamiento de la puerta: Escamoteable
 Linear 2da- Generación





Varia

Hogar	Altura de la puerta en cm	Estándar	Cromo		Acero fino pulido
			Brillo	Mate	

S	A	AM	VAG
---	---	----	-----

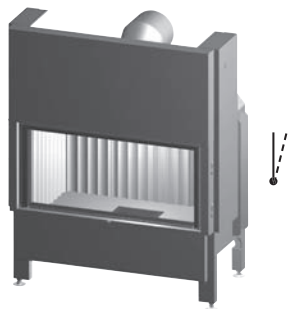

Varia Ah-3S

LINEAR 

	Batiente inferior (para limpiar)				
		42,8	3.296,-	-	-
		S 1018556	-	-	-
<input type="checkbox"/> Marcos remate obras, ahora en la página 38 Potencia térmica nominal: 10,4 kW Salida de humos: ø 200 mm Ancho de la puerta: 881 mm Funcionamiento de la puerta: Escamoteable  Marco presión					

Varia Ah-3S-2

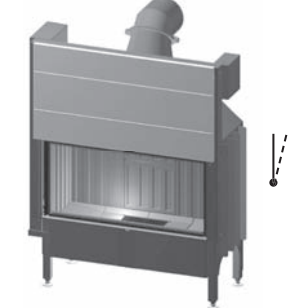
LINEAR 2 

	Batiente inferior (para limpiar)				
		43	3.415,-	-	-
		S 1018258	-	-	-
<input type="checkbox"/> Marcos remate obras, ahora en la página 39 Potencia térmica nominal: 9,0 kW Salida de humos: ø 200 mm Ancho de la puerta: 867 mm Funcionamiento de la puerta: Escamoteable  Linear 2da- Generación					

Varia





Hogar	Altura de la puerta en cm	Estándar	Cromo		Acero fino pulido
			Brillo	Mate	

S	A	AM	VAG
---	---	----	-----



Varia Bh-4S

LINEAR

	Batiente inferior (para limpiar)				
		52,4	3.802,-	4.446,-	4.446,-
		S 1018443	A 1018446	AM 1018447	VAG 1018448
<input type="checkbox"/> Marcos remate obras, ahora en la página 39 Potencia térmica nominal: 10,4 kW Salida de humos: ø 250 mm Ancho de la puerta: 1006 mm Funcionamiento de la puerta: Escamoteable  Marco presión					

Varia Bh-3S

LINEAR

	Batiente inferior (para limpiar)				
		49,3	3.802,-	-	-
		S 1018449	-	-	-
<input type="checkbox"/> Marcos remate obras, ahora en la página 39 Potencia térmica nominal: 10,4 kW Salida de humos: ø 250 mm Ancho de la puerta: 1006 mm Funcionamiento de la puerta: Escamoteable  Marco presión					



Varia

Hogar	Altura de la puerta en cm	Estándar	Cromo		Acero fino pulido
			Brillo	Mate	

S	A	AM	VAG
---	---	----	-----

Varia B-120h-4S

LINEAR 

	Batiente inferior (para limpiar)				
		52,3	4.054,-	4.909,-	4.909,-
		S 1007118	A 1011927	AM 1011928	VAG 1007120

Marcos remate obras, ahora en la página 39

Potencia térmica nominal:	15,0 kW
Salida de humos:	ø 250 mm
Ancho de la puerta:	1206 mm
Funcionamiento de la puerta:	Escamoteable con autocierre

 Incl. sistema de autocierre

 Marco presión

Varia B-120h-3S

LINEAR 

	Batiente inferior (para limpiar)				
		49,3	4.054,-	-	-
		S 1007632	-	-	-

Marcos remate obras, ahora en la página 39

Potencia térmica nominal:	15,0 kW
Salida de humos:	ø 250 mm
Ancho de la puerta:	1206 mm
Funcionamiento de la puerta:	Escamoteable con autocierre

 Incl. sistema de autocierre

 Marco presión

Varia





Hogar	Altura de la puerta en cm	Estándar	Cromo		Acero fino pulido
			Brillo	Mate	

S	A	AM	VAG
---	---	----	-----

Varia M-60h-4S

LINEAR 

	Batiente inferior (para limpiar)					
		52,4	2.616,-	3.227,-		3.227,-
			S 1014953	A 1014975	AM 1014976	VAG 1014972

 Marcos remate obras, ahora en la página 39

Potencia térmica nominal: 7,0 kW

Salida de humos: ø 200 mm

Ancho de la puerta: 602 mm

Funcionamiento de la puerta: Escamoteable

 Atención:
Los módulos laterales se deberán pedir únicamente en conjunto con el hogar. La combinación posterior no es posible.

 Marco presión

Varia M-80h-4S

LINEAR 

	Batiente inferior (para limpiar)					
		52,4	3.138,-	3.698,-		3.698,-
			S 1014954	A 1014979	AM 1014980	VAG 1014973

 Marcos remate obras, ahora en la página 39

Potencia térmica nominal: 9,0 kW

Salida de humos: ø 200 mm

Ancho de la puerta: 802 mm

Funcionamiento de la puerta: Escamoteable

 Atención:
Los módulos laterales se deberán pedir únicamente en conjunto con el hogar. La combinación posterior no es posible.

 Marco presión



Varia

Hogar	Altura de la puerta en cm	Estándar	Cromo		Acero fino pulido
			Brillo	Mate	

S	A	AM	VAG
---	---	----	-----

Varia M-100h-4S

LINEAR ^{4S}

	Batiente inferior (para limpiar)	52,4	3.660,-	4.307,-	4.307,-
		S 1014955	A 1014983	AM 1014984	VAG 1014974

Marcos remate obras, ahora en la página 39

Potencia térmica nominal: 11,0 kW

Salida de humos: ø 200 mm

Ancho de la puerta: 1006 mm

Funcionamiento de la puerta: Escamoteable

Atención:
Los módulos laterales se deberán pedir únicamente en conjunto con el hogar. La combinación posterior no es posible.

Marco presión

Varia M-60/80/100h

LINEAR ^{4S}

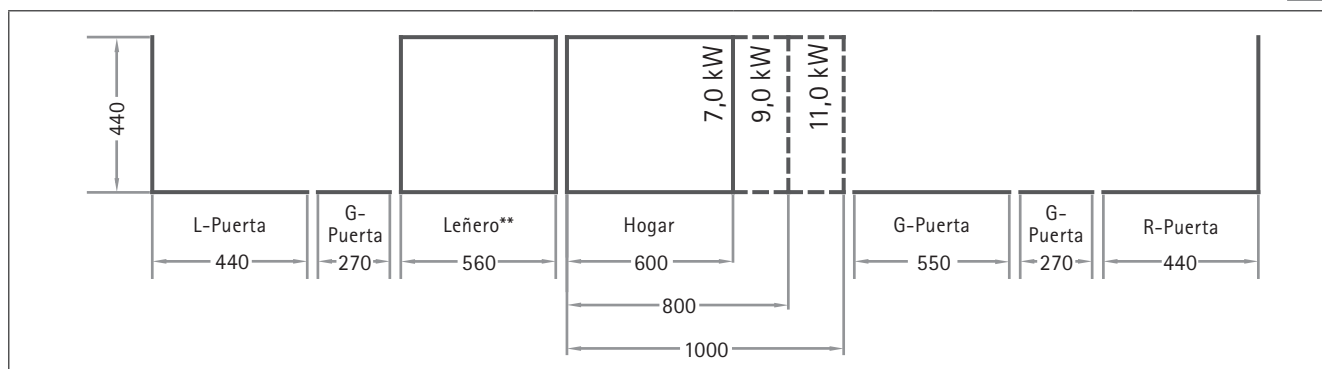

Potencia térmica nominal: 7,0/9,0/11,0 kW	M-60h	M-80h	M-100h	Atención: Hogar M-60/80/100h solo se puede pedir en combinación.	
Salida de humos: ø 200 mm	2.616,-	3.138,-	3.660,-		
Ancho de la puerta: 606/806/1010 mm	S 1009624	S 1009625	S 1009626	Puerta de cristal G270	Puerta de cristal G550
Funcionamiento de la puerta: Escamoteable	1.047,-	1.047,-	853,-	460,-	592,-
	S 1009627	S 1009628	S 1009629	S 1009630	S 1009631

** Posibilidad de colocar el leñero a la izq. o dcha. del hogar.

Arte



Hogar	Altura de la puerta en cm	Estándar	Cromo		Acero fino pulido
			Brillo	Mate	

S	A	AM	VAG
---	---	----	-----

Arte 1Vh-4S □

LINEAR ^{4S}

	Batiante inferior (para limpiar)				
		80,3	3.032,-	3.408,-	3.408,-
		S 1007137	A 1007133	AM 1007134	VAG 1007138
<input type="checkbox"/> Marcos remate obras, ahora en la página 41 Potencia térmica nominal: 8,0 kW Salida de humos: ø 180 mm Ancho de la puerta: 396 mm Funcionamiento de la puerta: Escamoteable Marco presión					

Arte Bh-4S ▽

LINEAR ^{4S}

	Batiante inferior (para limpiar)				
		80,3	3.344,-	3.722,-	3.722,-
		S 1007149	A 1007145	AM 1007146	VAG 1007150
<input type="checkbox"/> Marcos remate obras, ahora en la página 41 Potencia térmica nominal: 11,0 kW Salida de humos: ø 200 mm Ancho de la puerta: 656 mm Funcionamiento de la puerta: Escamoteable Marco presión					





Arte

Hogar	Altura de la puerta en cm	Estándar	Cromo		Acero fino pulido
			Brillo	Mate	

S	A	AM	VAG
---	---	----	-----



Arte Bh-3S

LINEAR 

	Batiante inferior (para limpiar)				
		79,3	3.344,-	-	-
<input type="checkbox"/> Marcos remate obras, ahora en la página 41 Potencia térmica nominal: 11,0 kW Salida de humos: ø 200 mm Ancho de la puerta: 656 mm Funcionamiento de la puerta: Escamoteable  Marco presión		S 1007198	-	-	-

Arte Xh-3S

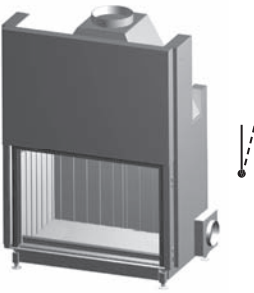
LINEAR 

	Batiante inferior (para limpiar)				
		66	4.556,-	-	-
<input type="checkbox"/> Marcos remate obras, ahora en la página 41 Potencia térmica nominal: 11,0 kW Salida de humos: ø 250 mm Ancho de la puerta: 988 mm Funcionamiento de la puerta: Escamoteable  Marco presión		S 1002250	-	-	-

Mini



Hogar	Altura de la puerta en cm	Estándar	Cromo		Acero fino pulido
			Brillo	Mate	

S	A	AM	VAG
---	---	----	-----

Mini S-FDh-4S □

LINEAR ^{4S}

	Batiente inferior (para limpiar)	51,3	3.008,-	3.596,-		3.596,-
			S 1009957	A 1009958	AM 1009959	VAG 1009960
		57,3	3.205,-	3.792,-		3.792,-
			S 1009961	A 1009962	AM 1009963	VAG 1009964
<input type="checkbox"/> Marcos remate obras, ahora en la página 37 Potencia térmica nominal: 6,0 kW Salida de humos: ø 200 mm Ancho de la puerta: 606 mm Funcionamiento de la puerta: Escamoteable Escamoteable solo por un lado Marco presión						

Mini S-FDh-3S □

LINEAR ^{3S}

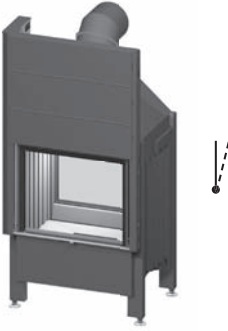
	Batiente inferior (para limpiar)	48,3	3.008,-	-	-
			S 1011101	-	-
<input type="checkbox"/> Marcos remate obras, ahora en la página 37 Potencia térmica nominal: 6,0 kW Salida de humos: ø 200 mm Ancho de la puerta: 606 mm Funcionamiento de la puerta: Escamoteable Escamoteable solo por un lado Marco presión					



Hogar	Altura de la puerta en cm	Estándar	Cromo		Acero fino pulido
			Brillo	Mate	

S	A	AM	VAG
---	---	----	-----

Varia FD-4S □

LINEAR ^{4S}

	Batiente izquierda	51	2.558,-	3.245,-		3.245,-
			S 1007034	A 1007030	AM 1007031	VAG 1007035
		57	2.689,-	3.366,-		3.366,-
			S 1007047	A 1007043	AM 1007044	VAG 1007048

<p>Potencia térmica nominal: 11,0 kW</p> <p>Salida de humos: ø 250 mm</p> <p>Ancho de la puerta: 674 mm</p> <p>Funcionamiento de la puerta: Batiente con autocierre</p>	Batiente derecha	51	2.558,-	3.245,-		3.245,-
			S 1007041	A 1007037	AM 1007038	VAG 1007042
		57	2.689,-	3.366,-		3.366,-
			S 1007053	A 1007049	AM 1007050	VAG 1007054

Varia FDh-4S □

LINEAR ^{4S}

	Batiente inferior (para limpiar)	51,3	3.228,-	3.913,-		3.913,-
			S 1007076	A 1007067	AM 1007068	VAG 1007078
		57,3	3.358,-	4.037,-		4.037,-
			S 1007088	A 1007080	AM 1007081	VAG 1007090

□ Marcos remate obras, ahora en la página 40

Potencia térmica nominal: 11,0 kW
Salida de humos: ø 250 mm
Ancho de la puerta: 671 mm
Funcionamiento de la puerta: Escamoteable
🔥 Escamoteable solo por un lado
🔥 Marco presión

Varia



Hogar	Altura de la puerta en cm	Estándar	Cromo		Acero fino pulido
			Brillo	Mate	

S	A	AM	VAG
---	---	----	-----

Varia FDh-3S

LINEAR ^{3S}

	Batiente inferior (para limpiar)	50,3	3.228,-	-	-
			S 1007191	-	-
		56,3	3.358,-	-	-
			S 1007193	-	-
<input type="checkbox"/> Marcos remate obras, ahora en la página 40 Potencia térmica nominal: 11,0 kW Salida de humos: ø 250 mm Ancho de la puerta: 671 mm Funcionamiento de la puerta: Escamoteable Escamoteable solo por un lado Marco presión					

Varia AS-FDh-4S-2

LINEAR 2 ^{4S}

	Batiente inferior (para limpiar)	37	2.756,-	3.489,-	3.489,-
			S 1020190	A 1020193	AM 1020194
		<input type="checkbox"/> Marcos remate obras, ahora en la página 38 Potencia térmica nominal: 7,0 kW Salida de humos: ø 180 mm Ancho de la puerta: 730 mm Funcionamiento de la puerta: Escamoteable Escamoteable solo por un lado Linear 2da- Generación			

Hogar	Altura de la puerta en cm	Estándar	Cromo		Acero fino pulido
			Brillo	Mate	

S	A	AM	VAG
---	---	----	-----

Varia A-FDh-4S

LINEAR 

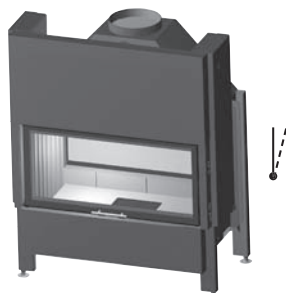
	Batiente inferior (para limpiar)				
		43,8	4.274,-	5.124,-	5.124,-
			S 1018567	A 1018570	AM 1018571

 Marcos remate obras, ahora en la página 40

Potencia térmica nominal: 10,4 kW

Salida de humos: ø 250 mm

Ancho de la puerta: 881 mm

Funcionamiento de la puerta: Escamoteable

 Escamoteable solo por un lado

 Marco presión

Varia A-FDh-3S

LINEAR 

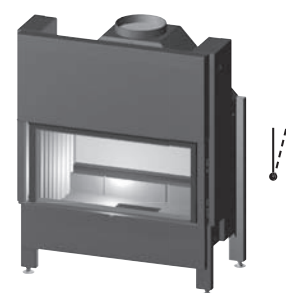
	Batiente inferior (para limpiar)				
		42,8	4.274,-	-	-
			S 1018573	-	-

 Marcos remate obras, ahora en la página 40

Potencia térmica nominal: 10,4 kW

Salida de humos: ø 250 mm

Ancho de la puerta: 881 mm

Funcionamiento de la puerta: Escamoteable

 Escamoteable solo por un lado

 Marco presión

Varia



Hogar	Altura de la puerta en cm	Estándar	Cromo		Acero fino pulido
			Brillo	Mate	

S	A	AM	VAG
---	---	----	-----

Varia B-FDh-4S

LINEAR

	Batiente inferior (para limpiar)				
		52,3	5.030,-	6.027,-	6.027,-
		S 1008713	A 1008715	AM 1008716	VAG 1008714

Marcos remate obras, ahora en la página 40

Potencia térmica nominal: 11,0 kW

Salida de humos: ø 250 mm

Ancho de la puerta: 1006 mm

Funcionamiento de la puerta: Escamoteable

Escamoteable solo por un lado

Marco presión

Varia B-FDh-3S

LINEAR

	Batiente inferior (para limpiar)				
		49,3	5.030,-	-	-
		S 1007631	-	-	-

Marcos remate obras, ahora en la página 40

Potencia térmica nominal: 11,0 kW

Salida de humos: ø 250 mm

Ancho de la puerta: 1006 mm

Funcionamiento de la puerta: Escamoteable

Escamoteable solo por un lado

Marco presión



Hogar	Altura de la puerta en cm	Estándar	Cromo		Acero fino pulido
			Brillo	Mate	

S	A	AM	VAG
---	---	----	-----

Arte X-FDh-3S □

LINEAR ^{3S}

	Batiente inferior (para limpiar)				
		66	5.763,-	-	-
		S 1002252	-	-	-
<p>□ Marcos remate obras, ahora en la página 41</p> <p>Potencia térmica nominal: 11,0 kW</p> <p>Salida de humos: ø 250 mm</p> <p>Ancho de la puerta: 988 mm</p> <p>Funcionamiento de la puerta: Escamoteable</p> <p>🔥 Escamoteable en ambos lados</p> <p>🔥 Marco presión</p>					

Mini 2L-4S/2R-4S □ □

LINEAR ^{4S}

	Batiente izquierda					
		49,5	1.964,-	2.344,-	2.344,-	
			S 1000266	A 1000262	AM 1000263	VAG 1000261
		55,5	2.095,-	2.466,-	2.466,-	
			S 1000276	A 1000272	AM 1000273	VAG 1000271
		<p>Potencia térmica nominal: 7,0 kW</p> <p>Salida de humos: ø 180 mm</p> <p>Ancho de la puerta: 452/452 mm</p> <p>Funcionamiento de la puerta: Batiente con autocierre</p>				
Batiente derecha						
	49,5	1.964,-	2.344,-	2.344,-		
		S 1000296	A 1000292	AM 1000293	VAG 1000291	
	55,5	2.095,-	2.466,-	2.466,-		
		S 1000306	A 1000302	AM 1000303	VAG 1000301	

Mini/Varia



Hogar	Altura de la puerta en cm	Estándar	Cromo		Acero fino pulido
			Brillo	Mate	

S	A	AM	VAG
---	---	----	-----

Mini 2LRh-4S

LINEAR ^{4S}

	Batiente izquierda (para limpiar)					
		50	2.485,-	2.844,-		2.844,-
			S 1000058	A 1000054	AM 1000055	VAG 1000053
		56	2.608,-	2.962,-		2.962,-
			S 1000068	A 1000064	AM 1000065	VAG 1000063
		<input type="checkbox"/> Marcos remate obras, ahora en la página 37 Potencia térmica nominal: 7,0 kW Salida de humos: ø 180 mm Ancho de la puerta: 465/465 mm Funcionamiento de la puerta: Escamoteable Utilizable para izquierda, o derecha. El suministro incluye dos asideros Marco presión				

Varia 2Lh

—PRESTIGE—



	Batiente derecha (para limpiar)					
		51,2	2.889,-	3.672,-		3.672,-
			S 1001458	A 1001454	AM 1001455	VAG 1001453
		57,2	2.999,-	3.780,-		3.780,-
			S 1001468	A 1001464	AM 1001465	VAG 1001463
		Potencia térmica nominal: 11,7 kW Salida de humos: ø 200 mm Ancho de la puerta: 685/465 mm Funcionamiento de la puerta: Escamoteable Marco presión				

Hogar	Altura de la puerta en cm	Estándar	Cromo		Acero fino pulido
			Brillo	Mate	

S	A	AM	VAG
---	---	----	-----



Varia 2L-100h-4S

LINEAR 

 <p>R</p>	Batiente derecha (para limpiar)				
		52,2	3.988,-	4.838,-	4.838,-
		S 1009185	A 1009973	AM 1009974	VAG 1009186
<p><input type="checkbox"/> Marcos remate obras, ahora en la página 40</p> <p>Potencia térmica nominal: 11,0 kW</p> <p>Salida de humos: ø 250 mm</p> <p>Ancho de la puerta: 1000/410 mm</p> <p>Funcionamiento de la puerta: Escamoteable</p> <p> Marco presión</p>					

Varia 2Rh

~~—PRESTIGE—~~

 <p>L</p>	Batiente izquierda (para limpiar)				
		51,2	2.889,-	3.672,-	3.672,-
		S 1001704	A 1001700	AM 1001701	VAG 1001699
		57,2	2.999,-	3.780,-	3.780,-
		S 1001714	A 1001710	AM 1001711	VAG 1001709
<p>Potencia térmica nominal: 11,7 kW</p> <p>Salida de humos: ø 200 mm</p> <p>Ancho de la puerta: 685/465 mm</p> <p>Funcionamiento de la puerta: Escamoteable</p> <p> Marco presión</p>					

Varia



Hogar	Altura de la puerta en cm	Estándar	Cromo		Acero fino pulido
			Brillo	Mate	

S	A	AM	VAG
---	---	----	-----

Varia 2R-100h-4S

LINEAR

	Batiente derecha (para limpiar)				
		52,2	3.988,-	4.838,-	4.838,-
		S 1009187	A 1009975	AM 1009976	VAG 1009188
<p> Marcos remate obras, ahora en la página 40</p> <p>Potencia térmica nominal: 11,0 kW</p> <p>Salida de humos: ø 250 mm</p> <p>Ancho de la puerta: 1000/410 mm</p> <p>Funcionamiento de la puerta: Escamoteable</p> <p> Marco presión</p>					

Varia C-45h

LINEAR

	Batiente izquierda (para limpiar)				
		52,6	3.333,-	3.690,-	3.690,-
		S 1015058	A 1015094	AM 1015095	VAG 1015059
<p>Potencia térmica nominal: 8,0 kW</p> <p>Salida de humos: ø 180 mm</p> <p>Ancho de la puerta: 191/450/191 mm</p> <p>Funcionamiento de la puerta: Escamoteable</p> <p> Bastidor-soporte especial T3S para instalación como separador de habitación con altura inferior al techo</p> <p> cristal de una pieza</p>					



Varia/Arte

Hogar	Altura de la puerta en cm	Estándar	Cromo		Acero fino pulido
			Brillo	Mate	

S	A	AM	VAG
---	---	----	-----

Varia Ch-4S □

LINEAR ^{4S}

	Batiente izquierda (para limpiar)				
		52,6	4.285,-	4.810,-	4.810,-
		S 1018356	A 1018359	AM 1018360	VAG 1018361

Potencia térmica nominal:	9,0 kW
Salida de humos:	ø 250 mm
Ancho de la puerta:	312/646/312 mm
Funcionamiento de la puerta:	Escamoteable
<ul style="list-style-type: none"> 🔥 Bastidor-soporte especial T3S para instalación como separador de habitación con altura inferior al techo 🔥 cristal frontal fijo durante limpieza 🔥 cristal de tres piezas 	

Arte U-50h-4S □

LINEAR ^{4S}

	Tope derecho e izquierdo				
		54,4 (ø 200)	4.443,-	5.077,-	5.077,-
		S 1011247	A 1011910	-	VAG 1011248
		54,4 (ø 250)	4.443,-	5.077,-	5.077,-
		S 1011813	A 1011914	-	VAG 1011814

Potencia térmica nominal:	9,0 kW
Salida de humos:	ø 200/250 mm
Ancho de la puerta:	499/501/499 mm
Funcionamiento de la puerta:	Escamoteable con autocierre
<ul style="list-style-type: none"> 🔥 Salida estándar de fábrica ø 200 mm Encargo especial ø 250 mm 🔥 cristal frontal fijo durante limpieza 🔥 Bastidor-soporte especial T3S para instalación como separador de habitación con altura inferior al techo 	



Hogar	Altura de la puerta en cm	Estándar	Cromo		Acero fino pulido
			Brillo	Mate	

S	A	AM	VAG
---	---	----	-----

Arte U-70h-4S

LINEAR ^{4S}

	Tope derecho e izquierdo					
		54,4 (ø 200)	5.035,-	5.753,-		5.753,-
			S 1009485	A 1011095	-	VAG 1009486
		54,4 (ø 250)	5.035,-	5.753,-		5.753,-
S 1010752	A 1011173		-	VAG 1010753		

Potencia térmica nominal:	11,0 kW
Salida de humos:	ø 200/250 mm
Ancho de la puerta:	713/501/713 mm

- Funcionamiento de la puerta: Escamoteable con autocierre
- 🔥 Salida estándar de fábrica Ø 200 mm
Encargo especial Ø 250 mm
 - 🔥 cristal frontal fijo durante limpieza
 - 🔥 Bastidor-soporte especial T3S para instalación como separador de habitación con altura inferior al techo

Arte U-90h-4S

LINEAR ^{4S}

	Tope derecho e izquierdo					
		54,4 (ø 200)	5.492,-	6.340,-		6.340,-
			S 1009487	A 1011174	-	VAG 1009488
		54,4 (ø 250)	5.492,-	6.340,-		6.340,-
S 1010754	A 1011175		-	VAG 1010755		

Potencia térmica nominal:	13,0 kW
Salida de humos:	ø 200/250 mm
Ancho de la puerta:	913/556/913 mm

- Funcionamiento de la puerta: Escamoteable con autocierre
- 🔥 Salida estándar de fábrica Ø 200 mm
Encargo especial Ø 250 mm
 - 🔥 cristal frontal fijo durante limpieza
 - 🔥 Bastidor-soporte especial T3S para instalación como separador de habitación con altura inferior al techo

Hogar	Altura de la puerta en cm	Estándar	Cromo		Acero fino pulido
			Brillo	Mate	

S	A	AM	VAG
---	---	----	-----

Arte 3RL-60h-4S □

LINEAR ^{4S}

	Tope derecho e izquierdo					
		57 (ø 200)	4.414,-	5.027,-		5.027,-
			S 1013631	A 1013634	AM 1013635	VAG 1013636
		57 (ø 250)	4.414,-	5.027,-		5.027,-
S 1013372	A 1013375		AM 1013376	VAG 1013377		

Potencia térmica nominal:	7,5 kW
Salida de humos:	ø 200/250 mm
Ancho de la puerta:	370/600/370 mm
Funcionamiento de la puerta:	Escamoteable
<ul style="list-style-type: none"> ⚠ Salida estándar de fábrica ø 200 mm Encargo especial ø 250 mm ⚠ cristal frontal fijo durante limpieza ⚠ Bastidor-soporte especial T3S para instalación como separador de habitación con altura inferior al techo 	

Arte 3RL-80h-4S □

LINEAR ^{4S}

	Tope derecho e izquierdo					
		57 (ø 200)	4.844,-	5.457,-		5.457,-
			S 1013637	A 1013640	AM 1013641	VAG 1013642
		57 (ø 250)	4.844,-	5.457,-		5.457,-
S 1013444	A 1013447		AM 1013448	VAG 1013449		

Potencia térmica nominal:	9,0 kW
Salida de humos:	ø 200/250 mm
Ancho de la puerta:	400/800/400 mm
Funcionamiento de la puerta:	Escamoteable
<ul style="list-style-type: none"> ⚠ Salida estándar de fábrica ø 200 mm Encargo especial ø 250 mm ⚠ cristal frontal fijo durante limpieza ⚠ Bastidor-soporte especial T3S para instalación como separador de habitación con altura inferior al techo 	

Arte/Varia







Hogar	Altura de la puerta en cm	Estándar	Cromo		Acero fino pulido
			Brillo	Mate	

S	A	AM	VAG
---	---	----	-----

Arte 3RL-100h-4S



LINEAR 

 L   R	Tope derecho e izquierdo				
		57	5.492,-	6.340,-	6.340,-
		S 1010422	A 1010441	AM 1010442	VAG 1010423

Potencia térmica nominal: 11,0 kW
 Salida de humos: ø 250 mm
 Ancho de la puerta: 450/1000/450 mm
 Funcionamiento de la puerta: Escamoteable
 Parabrisas fijo durante limpieza
 Bastidor-soporte especial T3S para instalación como separador de habitación con altura inferior al techo

Varia Eh-4S

LINEAR 

 L 	Batiante izquierda (para limpiar)				
		51	3.237,-	3.787,-	3.787,-
		S 1002110	A 1003464	AM 1003465	VAG 1002109

Potencia térmica nominal: 11,0 kW
 Salida de humos: ø 200 mm
 Ancho de la puerta: 754 mm
 Funcionamiento de la puerta: Escamoteable
 Radio del vidrio: R 1727 mm



Varia

Hogar	Altura de la puerta en cm	Estándar	Cromo		Acero fino pulido
			Brillo	Mate	

S	A	AM	VAG
---	---	----	-----

Varia BEh-4S



LINEAR 

	Batiente izquierda (para limpiar)				
		51,2	3.665,-	4.196,-	4.196,-
		S 1001407	A 1003460	AM 1003461	VAG 1001406

Potencia térmica nominal:	11,0 kW
Salida de humos:	ø 250 mm
Ancho de la puerta:	1020 mm
Funcionamiento de la puerta:	Escamoteable
Radio del vidrio:	R 2006 mm



Varia M-60h GET

LINEAR 

	Batiente inferior (para limpiar)				
		51,4	2.965,-	3.297,-	3.297,-
		S 1016352	A 1016355	AM 1016356	VAG 1016357
		Varia M-60h GET cubierta aislante (DH) - Complemento (con sobrepeso):	1016351	585,-	
 accesorios especiales, véase la página 34					

Marcos remate obras, ahora en la página 39

Varia M-60h GET DH

	Batiente inferior (para limpiar)		
		<input type="checkbox"/> Marcos remate obras, ahora en la página 39	
		Potencia térmica nominal:	8,0 kW
Salida de humos:	ø 180 mm		
Ancho de la puerta:	606 mm		
Funcionamiento de la puerta:	Escamoteable		
 Marco presión			



Varia

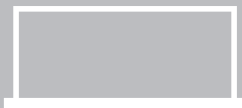

Hogar	Altura de la puerta en cm	Estándar	Cromo		Acero fino pulido
			Brillo	Mate	

S	A	AM	VAG
---	---	----	-----

Varia M-80h GET

LINEAR ^{4S}

	Batiante inferior (para limpiar)	52	3.369,-	3.784,-	3.784,-
		S 1017856	A 1017859	AM 1017860	VAG 1017861
<input type="checkbox"/> Marcos remate obras, ahora en la página 39		Varia M-80h GET cubierta aislante (DH) - Complemento (con sobreprecio): 1017833			622,-
<input type="checkbox"/> accesorios especiales, véase la página 34					

Varia M-80h GET DH

	Batiante inferior (para limpiar)
<input type="checkbox"/> Marcos remate obras, ahora en la página 39	
Potencia térmica nominal:	9,0 kW
Salida de humos:	ø 180 mm
Ancho de la puerta:	802 mm
Funcionamiento de la puerta:	Escamoteable

LINEAR ^{4S}

Varia M-100h GET

	Batiante inferior (para limpiar)	52	3.945,-	4.347,-	4.347,-
		S 1017866	A 1017869	AM 1017870	VAG 1017871
<input type="checkbox"/> Marcos remate obras, ahora en la página 40		Varia M-100h GET cubierta aislante (DH) - Complemento (con sobreprecio): 1017876			679,-
<input type="checkbox"/> accesorios especiales, véase la página 34					

Varia M-100h GET DH

	Batiante inferior (para limpiar)
<input type="checkbox"/> Marcos remate obras, ahora en la página 40	
Potencia térmica nominal:	10,4 kW
Salida de humos:	ø 180 mm
Ancho de la puerta:	1006 mm
Funcionamiento de la puerta:	Escamoteable
<input type="checkbox"/> Marco presión	



Varia

Hogar	Altura de la puerta en cm	Estándar	Cromo		Acero fino pulido
			Brillo	Mate	

S	A	AM	VAG
---	---	----	-----

Varia 2L-55h GET

LINEAR ^{4S}

	Batiante derecha (para limpiar) R	51,2	2.965,-	3.297,-	3.297,-
		S 1016343	A 1016346	AM 1016347	VAG 1016348
Varia 2L-55h GET cubierta aislante (DH) - Complemento (con sobreprecio):					1016350 585,-
🔥 accesorios especiales, véase la página 34					

Varia 2L-55h GET DH

	Batiante derecha (para limpiar) R
Potencia térmica nominal: 7,0 kW	
Salida de humos: ø 180 mm	
Ancho de la puerta: 583/391 mm	
Funcionamiento de la puerta: Escamoteable	

Varia 2R-55h GET

LINEAR ^{4S}

	Batiante izquierda (para limpiar) L	51,2	2.965,-	3.297,-	3.297,-
		S 1016337	A 1016340	AM 1016341	VAG 1016342
Varia 2R-55h GET cubierta aislante (DH) - Complemento (con sobreprecio):					1016349 585,-
🔥 accesorios especiales, véase la página 34					

Varia 2R-55h GET DH

	Batiante izquierda (para limpiar) L
Potencia térmica nominal: 7,0 kW	
Salida de humos: ø 180 mm	
Ancho de la puerta: 583/391 mm	
Funcionamiento de la puerta: Escamoteable	
🔥 Marco presión	

Artículo	Denominación	Dimensiones en mm	Precio / N.º de artículo
----------	--------------	-------------------	--------------------------

Elemento de conexión chimenea

	Para Varia M-60/80/100h GET (DH)	180/245 mm; L 150 mm	209,-	1016906
	Elemento de doble pared, acero inoxidable, aislado Ø 180 mm, para la conexión directa posterior, desde la salida de humos.			
	Para Varia 2L/R-55h GET (DH)	180/245 mm; L 175 mm	227,-	1016902
Elemento de doble pared, acero inoxidable, aislado Ø 180 mm, para la conexión directa posterior, desde la salida de humos.				
Para Varia M-60/80/100h GET (DH)	180/245 mm; L 400 mm	275,-	1016907	
Elemento de conexión chimenea de doble pared, aislado, acero inoxidable con adaptador para la salida de humos Ø 180 mm y conexión superior a través de la perforación del carenado superior (DH); adaptador para la conexión de extensiones del sistema Jeremias o tubos de chimenea habituales.				

Codo

	Codo 15°	180/245 mm, 15°	127,-	1016883
	Codo de doble pared aislado, acero inoxidable, 15°			
	Codo 30°	180/245 mm, 30°	135,-	1016886
	Codo de doble pared aislado, acero inoxidable, 30°			
	Codo 45°	180/245 mm, 45°	130,-	1016887
	Codo de doble pared aislado, acero inoxidable, 45°			
Codo 90°	180/245 mm, 90°	266,-	1016888	
Codo de doble pared aislado, acero inoxidable, 90°				
Codo 90° RK	180/245 mm, 90°	368,-	1016889	
Codo de doble pared aislado, acero inoxidable, 90° con puerta de limpieza				

Tubo recto

	Tubo recto 1000 mm	180/245 mm/1000 mm	244,-	1016890
	Tubo recto de doble pared aislado 1000 mm, individualmente acortable			
	Tubo recto 500 mm	180/245 mm/500 mm	140,-	1016892
Tubo recto de doble pared aislado 500 mm, individualmente acortable				
Tubo recto 250 mm	180/245 mm/250 mm	94,-	1016893	
Tubo recto de doble pared aislado 250 mm, individualmente acortable				

Manguito de entrada

	Manguito de entrada 180 mm	245 mm/176 mm	60,-	1016894
Manguito de entrada a la chimenea de parte aislada den 245 mm a cuello de 180 mm				

Separador pared

	Separador pared 150 mm	245 mm/150 mm	94,-	1016895
	Separador de abrazadera para la fijación del sistema de chimenea			
Separador pared 250 mm	245 mm/250 mm	109,-	1016896	
Separador de abrazadera para la fijación del sistema de chimenea				

Cassetes a medida con puerta de autocierre según DIN EN 13229

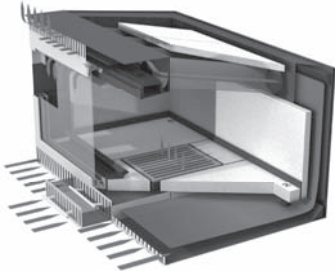
Esquema de funcionamiento	Frontal hasta mm	Profundidad max. mm	Altura max. mm	1V	2L/2R	3RL	Prisma
 <p>(En la página 55 encontrará un esquema en color)</p> <p>Cassette pequeño (hasta un frontal de 700 mm) Potencia nominal: 6,0 kW</p> <p>Cassette grande (a partir de un frontal de 700 mm) Potencia nominal: 8,0 kW</p>	600	500	500	1.945,-	2.139,-	2.306,-	2.444,-
				1003014	1002998/1003006	1002990	1003022
	700	500	500	2.110,-	2.306,-	2.473,-	2.655,-
				1003015	1002999/1003007	1002991	1003023
	800	500	500	2.263,-	2.473,-	2.625,-	2.866,-
				1003016	1003000/1003008	1002992	1003024
	900	500	500	2.427,-	2.625,-	2.706,-	3.124,-
				1003017	1003001/1003009	1002993	1003025
1000	500	500	2.595,-	2.837,-	3.064,-	3.366,-	
			1003010	1002994/1003002	1002986	1003018	
1100	500	500	2.837,-	3.064,-	3.230,-	3.775,-	
			1003011	1002995/1003003	1002987	1003019	
1200	500	500	3.064,-	3.306,-	3.473,-	4.123,-	
			1003012	1002996/1003004	1002988	1003020	
1300	500	500	3.306,-	3.548,-	3.716,-	4.485,-	
			1003013	1002997/1003005	1002989	1003021	

Accesorios

Profundidades e alturas superiores a 500 mm por cada 100 mm comenzados	1003041	99,-
Material de instalación „junta cordon“	1003032	63,-
Bastidor de puerta dorado / cromado por cada 100 mm comenzados	1003042	20,-
Regillas de admisión y salida de aire doradas / cromadas por cada 100 mm comenzados	1003034	15,-
Turbina con regulación de revoluciones integrada. Solo a partir de un Frontal de 600 mm	1003033	320,-
Suplemento puerta de dos alas (recomendado a partir de una anchura de 800 mm y una altura de 500 mm) en general a partir de un frontal de 1000 mm	1003030	160,-
Suplemento por cada puerta lateral de ángulo abatible (a partir de una anchura de 360mm)	1003043	63,-
Escotadura por cada esquina	1003031	124,-
Marco remate > 15 mm por pza.	1003029	39,-
Trampilla de vaciado de cenizas al sótano	1003026	124,-
Marco Remate en arco según padrón o dibujo	1003040	124,-
Cuerpo en forma de arco, según padrón o dibujo con un solo radio claramente definido	1003039	785,-
Cuerpo en forma de arco, según padrón o dibujo con múltiples radios	1006401	1.373,-
Ejecución „Luxus“ (remate dorado o cromado)	1003035	149,-
Salida de humos para atornillar desde el interior	1003027	307,-
Colector de humos para atornillar	1003028	595,-
Marco angular atornillado	1005348	76,-
Marcos remate en dorado o cromado por cada 100 mm comenzados	1003034	15,-



S-Air

Artículo	Descripción	Precio / N.º de artículo
----------	-------------	--------------------------

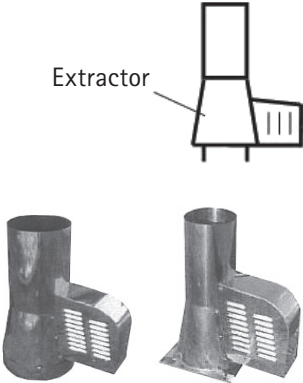
S - Kamatik Plus

	S-Kamatik Plus <i>Extractor de humos</i>		
	el suministro incluye: Cordón de seguridad de acero Cable de conexión de 3 m longitud Regulador de potencia (manual)		
	Set 2 - versión ensamblable ø 150 mm	715,-	1011446
	Set 3 - versión ensamblable ø 200 mm	787,-	1011447
	Set 4 - versión remate obra placa rectangular puret ø 150 mm	715,-	1011448
	Set 5 - versión remate obra placa rectangular puret ø 200 mm	787,-	1011449

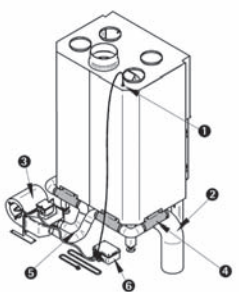
S-Vent

Ejemplo de instalación Varia 1Vh	Convección modular forzada	502,-	1009947
	Aumento de la aportación del aire de convección hasta un 75 % Por medio de turbina silenciosa. El carenado permanece abierto en la parte inferior de forma que mantiene la posibilidad del funcionamiento con convección natural (sin turbina). Gracias a la construcción modular sirve para todos los carenados de todas las gamas y modelos.		
	el suministro incluye: 1 tubo flexible de aluminio de 5 m 1 Caja control con telecomando 1 Turbina con abrazadera de montaje 2 Tapas de chapa 4 Tubos inyectores Tornillos y bornes		
 Sirve para todos los tipos de carenado de todos los modelos			
1) Sensor de temperatura 2) Aire de combustión externo 3) Unidad turbina 4) Tubos inyectores máx. 4 piezas 5) Tubo exterior 6) Caja control			

Mando de apertura electrónico de puerta de hogar con puerta o a medida

	1.280,-	1011981
	Mando de apertura electrónico de puerta de hogar (para hogares con puerta frontal 1Vh de serie) Para ser operado con control remoto en caso de corte eléctrico la puerta puede ser abierta con la „mano fría“ Bajo pedido solamente en conjunto con el hogar.	
Hogares a medida, bi- o trifaciales		bajo demanda

Accesorios

Marcos remate de obras

Serie Mini



Marco remate obra macizo
6mm



Marco remate obra con
borde de 3mm

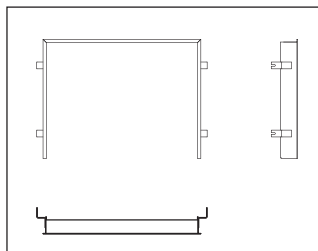

Marco remate obra de 3 lados
(borde 3mm)

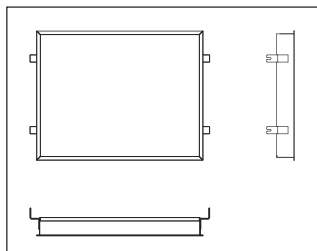

Marco remate obra de 4 lados
(borde 3mm)

Indicación:



Volumen de suministro incluye los elementos de suspensión para:



Modelos de 2 lados

Modelos de 3 lados

Modelos con cristales frontales >740mm.

Mini R1Vh-4S 	Altura de la puerta		LINEAR 
de tres lados	57,3	S	1007908 115,-
	57,3	A	1007909 186,-
	57,3	AM	1008649 186,-
	57,3	VAG	1007910 186,-
de tres lados, macizo	57,3	S	1020893 278,-
de tres lados, macizo	57,3	VAG	1020894 434,-
de cuatro lados	57,3	S	1007772 150,-
	57,3	A	1007775 246,-
	57,3	AM	1008673 246,-
	57,3	VAG	1007778 246,-
de cuatro lados, macizo	57,3	S	1020895 323,-
de cuatro lados, macizo	57,3	VAG	1020896 478,-

Mini Sh-4S  Mini S-FDh-4S 			LINEAR 
de tres lados	51,3	S	1008936 115,-
	51,3	A	1008937 186,-
	51,3	AM	1008938 186,-
	51,3	VAG	1008939 186,-
de tres lados, macizo	51,3	S	1020562 278,-
de tres lados, macizo	51,3	VAG	1020563 434,-
de tres lados	57,3	S	1010047 115,-
	57,3	A	1010045 186,-
	57,3	AM	1010046 186,-
	57,3	VAG	1010049 186,-
de tres lados, macizo	57,3	S	1020659 278,-
de tres lados, macizo	57,3	VAG	1020660 434,-
de cuatro lados	51,3	S	1008940 150,-
	51,3	A	1008941 246,-
	51,3	AM	1008942 246,-
	51,3	VAG	1008943 246,-
de cuatro lados, macizo	51,3	S	1020564 323,-
de cuatro lados, macizo	51,3	VAG	1020565 478,-
de cuatro lados	57,3	S	1010052 150,-
	57,3	A	1010050 246,-
	57,3	AM	1010051 246,-
	57,3	VAG	1010053 246,-
de cuatro lados, macizo	57,3	S	1020897 323,-
de cuatro lados, macizo	57,3	VAG	1020898 478,-

Mini Sh-3S  Mini S-FDh-3S 			LINEAR 
de tres lados	48,3	S	1011204 139,-
de tres lados, macizo	48,3	S	1020566 278,-
de cuatro lados	48,3	S	1011205 186,-
de cuatro lados, macizo	48,3	S	1020567 323,-











Mini 2LRh-4S 			LINEAR 
de cuatro lados	50	S	1020690 312,-
	50	VAG	1020694 456,-
de seis lados	50	S	1020691 323,-
	50	VAG	1020695 478,-
de cuatro lados, macizo	50	S	1020692 312,-
de cuatro lados, macizo	50	VAG	1020696 456,-
de seis lados, macizo	50	S	1020693 323,-
de seis lados, macizo	50	VAG	1020697 478,-
de cuatro lados	56	S	1020698 312,-
	56	VAG	1020699 456,-
de seis lados	56	S	1020700 323,-
	56	VAG	1020701 478,-
de cuatro lados, macizo	56	S	1020702 312,-
de cuatro lados, macizo	56	VAG	1020703 456,-
de seis lados, macizo	56	S	1020704 323,-
de seis lados, macizo	56	VAG	1020705 478,-

Accesorios

Marcos remate de obras



Serie Varia



Varia 1Vh-4S 	Altura de la puerta		LINEAR 
de tres lados	45,3	S	1007926 162,-
	45,3	A	1007927 299,-
	45,3	AM	1008655 299,-
	45,3	VAG	1007929 299,-
de tres lados, macizo	45,3	S	1020578 287,-
de tres lados, macizo	45,3	VAG	1020579 467,-
de tres lados	51,3	S	1007930 162,-
	51,3	A	1007931 299,-
	51,3	AM	1008656 299,-
	51,3	VAG	1007932 299,-
de tres lados, macizo	51,3	S	1020580 312,-
de tres lados, macizo	51,3	VAG	1020581 467,-
de tres lados	57,3	S	1007933 162,-
	57,3	A	1007934 299,-
	57,3	AM	1008657 299,-
	57,3	VAG	1007935 299,-
de tres lados, macizo	57,3	S	1020582 312,-
de tres lados, macizo	57,3	VAG	1020583 467,-
de cuatro lados	45,3	S	1007794 216,-
	45,3	A	1007797 400,-
	45,3	AM	1008679 400,-
	45,3	VAG	1007800 400,-
de cuatro lados, macizo	45,3	S	1020584 356,-
de cuatro lados, macizo	45,3	VAG	1020585 512,-
de cuatro lados	51,3	S	1007795 216,-
	51,3	A	1007798 400,-
	51,3	AM	1008680 400,-
	51,3	VAG	1007801 400,-
de cuatro lados, macizo	51,3	S	1020586 356,-
de cuatro lados, macizo	51,3	VAG	1020587 512,-
de cuatro lados	57,3	S	1007796 216,-
	57,3	A	1007799 400,-
	57,3	AM	1008681 400,-
	57,3	VAG	1007802 400,-
de cuatro lados, macizo	57,3	S	1020588 356,-
de cuatro lados, macizo	57,3	VAG	1020589 512,-
Varia 1Vh-3S 			LINEAR 
de tres lados	45,3	S	1008037 139,-
de tres lados, macizo	45,3	S	1020590 312,-
de tres lados	51,3	S	1008038 139,-
de tres lados, macizo	51,3	S	1020591 312,-
de tres lados	57,3	S	1008039 139,-
de tres lados, macizo	57,3	S	1020593 312,-
de cuatro lados	45,3	S	1008024 186,-
de cuatro lados, macizo	45,3	S	1020594 356,-
de cuatro lados	51,3	S	1008025 186,-
de cuatro lados, macizo	51,3	S	1020595 356,-
de cuatro lados	57,3	S	1008026 186,-
de cuatro lados, macizo	57,3	S	1020596 356,-
Varia Sh-4S 			LINEAR 
de tres lados	62,3	S	1007957 162,-
	62,3	A	1007958 299,-
	62,3	AM	1008667 299,-
	62,3	VAG	1007959 299,-
de tres lados, macizo	62,3	S	1020597 312,-
de tres lados, macizo	62,3	VAG	1020598 467,-



Varia Sh-4S 	Altura de la puerta		LINEAR 
de cuatro lados	62,3	S	1007824 216,-
	62,3	A	1007825 400,-
	62,3	AM	1008690 400,-
	62,3	VAG	1007826 400,-
de cuatro lados, macizo	62,3	S	1020600 356,-
de cuatro lados, macizo	62,3	VAG	1020601 512,-
Varia Sh-3S 			LINEAR 
de tres lados	59,3	S	1008048 139,-
de tres lados, macizo	59,3	S	1020602 312,-
de cuatro lados	59,3	S	1008035 186,-
de cuatro lados, macizo	59,3	S	1020603 467,-
Varia ASH-4S-2  Varia AS FDh-4S-2 			LINEAR 2 
de tres lados	37	S	1020947 156,-
	37	A	1020950 288,-
	37	AM	1020952 288,-
	37	VAG	1020953 288,-
de tres lados, macizo	37	S	1020962 312,-
de tres lados, macizo	37	VAG	1020963 467,-
de cuatro lados	37	S	1020954 208,-
	37	A	1020958 386,-
	37	AM	1020960 386,-
	37	VAG	1020961 386,-
de cuatro lados, macizo	37	S	1020964 356,-
de cuatro lados, macizo	37	VAG	1020965 512,-
Varia Ah-4S 			LINEAR 
de tres lados	43,8	S	1007936 162,-
	43,8	A	1007937 299,-
	43,8	AM	1008659 299,-
	43,8	VAG	1007938 299,-
de tres lados, macizo	43,8	S	1020604 312,-
de tres lados, macizo	43,8	VAG	1020605 467,-
de cuatro lados	43,8	S	1007803 216,-
	43,8	A	1007804 400,-
	43,8	AM	1008683 400,-
	43,8	VAG	1007805 400,-
de cuatro lados, macizo	43,8	S	1020606 356,-
de cuatro lados, macizo	43,8	VAG	1020607 512,-
Varia Ah-4S-2 			LINEAR 2 
de tres lados	43	S	1018234 162,-
	43	A	1018237 299,-
	43	AM	1018238 299,-
	43	VAG	1018239 299,-
de tres lados, macizo	43	S	1020609 312,-
de tres lados, macizo	43	VAG	1020611 467,-
de cuatro lados	43	S	1018240 216,-
	43	A	1018243 400,-
	43	AM	1018244 400,-
	43	VAG	1018245 400,-
de cuatro lados, macizo	43	S	1020612 356,-
de cuatro lados, macizo	43	VAG	1020614 512,-
Varia Ah-3S 			LINEAR 
de tres lados	42,8	S	1008040 139,-
de tres lados, macizo	42,8	S	1020615 312,-
de cuatro lados	42,8	S	1008027 186,-
de cuatro lados, macizo	42,8	S	1020616 356,-

Accesorios



Marcos remate de obras



Varia Ah-3S-2 	Altura de la puerta		LINEAR 
de tres lados	43	S	1018246 139,-
de tres lados, macizo	43	S	1020617 312,-
de cuatro lados	43	S	1018247 186,-
de cuatro lados, macizo	43	S	1020618 356,-

Varia Bh-4S 			LINEAR 
de tres lados	52,4	S	1007942 162,-
	52,4	A	1007943 299,-
	52,4	AM	1008662 299,-
	52,4	VAG	1007944 299,-
de tres lados, macizo	52,4	S	1020627 312,-
de tres lados, macizo	52,4	VAG	1020628 467,-
de cuatro lados	52,4	S	1007809 216,-
	52,4	A	1007810 400,-
	52,4	AM	1008685 400,-
	52,4	VAG	1007811 400,-
de cuatro lados, macizo	52,4	S	1020629 356,-
de cuatro lados, macizo	52,4	VAG	1020630 512,-



Varia Bh-3S 			LINEAR 
de tres lados	49,3	S	1008042 139,-
de tres lados, macizo	49,3	S	1020619 312,-
de cuatro lados	49,3	S	1008029 186,-
de cuatro lados, macizo	49,3	S	1020620 356,-



Varia B-120h-4S 			LINEAR 
de tres lados	52,3	S	1007945 162,-
	52,3	A	1007946 299,-
	52,3	AM	1012038 299,-
	52,3	VAG	1007947 299,-
de tres lados, macizo	52,3	S	1020621 312,-
de tres lados, macizo	52,3	VAG	1020622 467,-
de cuatro lados	52,3	S	1007812 216,-
	52,3	A	1007813 400,-
	52,3	AM	1012041 400,-
	52,3	VAG	1007814 400,-
de cuatro lados, macizo	52,3	S	1020623 356,-
de cuatro lados, macizo	52,3	VAG	1020624 512,-



Varia B-120h-3S 			LINEAR 
de tres lados	49,3	S	1008044 139,-
de tres lados, macizo	49,3	S	1020631 312,-
de cuatro lados	49,3	S	1008031 186,-
de cuatro lados, macizo	49,3	S	1020632 356,-

Varia M-60h-4S 			LINEAR 
de tres lados	52,4	S	1014988 162,-
	52,4	A	1014989 299,-
	52,4	AM	1014990 299,-
	52,4	VAG	1014993 299,-
de tres lados, macizo	52,4	S	1020633 312,-
de tres lados, macizo	52,4	VAG	1020634 467,-
de cuatro lados	52,4	S	1014994 216,-
	52,4	A	1014995 400,-
	52,4	AM	1014996 400,-
	52,4	VAG	1014999 400,-
de cuatro lados, macizo	52,4	S	1020635 356,-
de cuatro lados, macizo	52,4	VAG	1020636 512,-

Varia M-60h GET 	Altura de la puerta		LINEAR 
de tres lados	51,4	S	1017573 162,-
	51,4	A	1017574 299,-
	51,4	AM	1017575 299,-
	51,4	VAG	1017576 299,-
de tres lados, macizo	51,4	S	1020876 312,-
de tres lados, macizo	51,4	VAG	1020877 467,-
de cuatro lados	51,4	S	1017577 216,-
	51,4	A	1017578 400,-
	51,4	AM	1017579 400,-
	51,4	VAG	1017580 400,-
de cuatro lados, macizo	51,4	S	1020878 356,-
de cuatro lados, macizo	51,4	VAG	1020879 512,-

Varia M-80h-4S 			LINEAR 
de tres lados	52,4	S	1015000 162,-
	52,4	A	1015001 299,-
	52,4	AM	1015002 299,-
	52,4	VAG	1015005 299,-
de tres lados, macizo	52,4	S	1020637 312,-
de tres lados, macizo	52,4	VAG	1020638 467,-
de cuatro lados	52,4	S	1015006 216,-
	52,4	A	1015007 400,-
	52,4	AM	1015008 400,-
	52,4	VAG	1015011 400,-
de cuatro lados, macizo	52,4	S	1020639 356,-
de cuatro lados, macizo	52,4	VAG	1020640 512,-

Varia M-80h GET 			LINEAR 
de tres lados	52	S	1018293 162,-
	52	A	1018294 299,-
	52	AM	1018295 299,-
	52	VAG	1018298 299,-
de tres lados, macizo	52	S	1020880 312,-
de tres lados, macizo	52	VAG	1020881 467,-
de cuatro lados	52	S	1018299 216,-
	52	A	1018300 400,-
	52	AM	1018301 400,-
	52	VAG	1018304 400,-
de cuatro lados, macizo	52	S	1020882 356,-
de cuatro lados, macizo	52	VAG	1020883 512,-



Varia M-100h-4S 			LINEAR 
de tres lados	52,4	S	1015012 162,-
	52,4	A	1015013 299,-
	52,4	AM	1015014 299,-
	52,4	VAG	1015017 299,-
de tres lados, macizo	52,4	S	1020641 312,-
de tres lados, macizo	52,4	VAG	1020642 467,-
de cuatro lados	52,4	S	1015018 216,-
	52,4	A	1015019 400,-
	52,4	AM	1015020 400,-
	52,4	VAG	1015023 400,-
de cuatro lados, macizo	52,4	S	1020643 356,-
de cuatro lados, macizo	52,4	VAG	1020644 512,-

Accesorios



Marcos remate de obras



Varia M-100h GET 	Altura de la puerta		LINEAR 
de tres lados	52	S	1018306 162,-
	52	A	1018308 299,-
	52	AM	1018310 299,-
	52	VAG	1018315 299,-
de tres lados, macizo	52	S	1020884 312,-
de tres lados, macizo	52	VAG	1020885 467,-
de cuatro lados	52	S	1018316 216,-
	52	A	1018318 400,-
	52	AM	1018319 400,-
	52	VAG	1018323 400,-
de cuatro lados, macizo	52	S	1020886 356,-
de cuatro lados, macizo	52	VAG	1020887 512,-



Varia FDh-4S 			LINEAR 
de tres lados	51,3	S	1007951 162,-
	51,3	A	1007952 299,-
	51,3	AM	1008664 299,-
	51,3	VAG	1007953 299,-
de tres lados, macizo	51,3	S	1020661 312,-
de tres lados, macizo	51,3	VAG	1020662 467,-
de tres lados	57,3	S	1007954 162,-
	57,3	A	1007955 299,-
	57,3	AM	1008665 299,-
	57,3	VAG	1007956 299,-
de tres lados, macizo	57,3	S	1020663 312,-
de tres lados, macizo	57,3	VAG	1020664 467,-
de cuatro lados	51,3	S	1007816 216,-
	51,3	A	1008687 400,-
	51,3	AM	1007819 400,-
	51,3	VAG	1007822 400,-
de cuatro lados, macizo	51,3	S	1020665 356,-
de cuatro lados, macizo	51,3	VAG	1020666 512,-
de cuatro lados	57,3	S	1007817 216,-
	57,3	A	1007820 400,-
	57,3	AM	1008688 400,-
	57,3	VAG	1007823 400,-
de cuatro lados, macizo	57,3	S	1020667 356,-
de cuatro lados, macizo	57,3	VAG	1020668 512,-



Varia FDh-3S 			LINEAR 
de tres lados	50,3	S	1008046 139,-
de tres lados, macizo	50,3	S	1020669 312,-
de tres lados	56,3	S	1008047 139,-
de tres lados, macizo	56,3	S	1020670 467,-
de cuatro lados	50,3	S	1008033 186,-
de cuatro lados, macizo	50,3	S	1020671 312,-
de cuatro lados	56,3	S	1008034 186,-
de cuatro lados, macizo	56,3	S	1020672 467,-



Varia A-FDh-4S 			LINEAR 
de tres lados	43,8	S	1007939 162,-
	43,8	A	1007940 299,-
	43,8	AM	1008658 299,-
	43,8	VAG	1007941 299,-
de tres lados, macizo	43,8	S	1020673 312,-
de tres lados, macizo	43,8	VAG	1020675 467,-
de cuatro lados	43,8	S	1007806 216,-
	43,8	A	1007807 400,-
	43,8	AM	1008682 400,-
	43,8	VAG	1007808 400,-
de cuatro lados, macizo	43,8	S	1020676 356,-
de cuatro lados, macizo	43,8	VAG	1020677 512,-

Varia A-FDh-3S 	Altura de la puerta		LINEAR 
de tres lados	52,3	S	1008041 139,-
de tres lados, macizo	52,3	S	1020678 312,-
de cuatro lados	52,3	S	1008028 186,-
de cuatro lados, macizo	52,3	S	1020679 356,-

Varia B-FDh-4S 			LINEAR 
de tres lados	42,8	S	1008216 162,-
	42,8	A	1008217 299,-
	42,8	AM	1008661 299,-
	42,8	VAG	1008218 299,-
de tres lados, macizo	42,8	S	1020680 312,-
de tres lados, macizo	42,8	VAG	1020899 467,-
de cuatro lados	42,8	S	1008717 216,-
	42,8	A	1008718 400,-
	42,8	AM	1008719 400,-
	42,8	VAG	1008720 400,-
de cuatro lados, macizo	42,8	S	1020685 356,-
de cuatro lados, macizo	42,8	VAG	1020900 512,-

Varia B-FDh-3S 			LINEAR 
de tres lados	49,3	S	1008043 139,-
de tres lados, macizo	49,3	S	1020686 312,-
de cuatro lados	49,3	S	1008030 186,-
de cuatro lados, macizo	49,3	S	1020687 356,-



Varia 2L-100h-4S 			LINEAR 
de cuatro lados	51,2	S	1020759 345,-
	51,2	VAG	1020760 489,-
de seis lados	51,2	S	1020761 356,-
	51,2	VAG	1020762 512,-
de cuatro lados, macizo	51,2	S	1020763 345,-
de cuatro lados, macizo	51,2	VAG	1020764 489,-
de seis lados, macizo	51,2	S	1020765 356,-
de seis lados, macizo	51,2	VAG	1020766 512,-



Varia 2R-100h-4S 			LINEAR 
de cuatro lados	51,2	S	1020767 345,-
	51,2	VAG	1020768 489,-
de seis lados	51,2	S	1020769 356,-
	51,2	VAG	1020770 512,-
de cuatro lados, macizo	51,2	S	1020772 345,-
de cuatro lados, macizo	51,2	VAG	1020773 489,-
de seis lados, macizo	51,2	S	1020774 356,-
de seis lados, macizo	51,2	VAG	1020775 512,-



Serie Arte

Arte 1Vh-4S 	Altura de la puerta		LINEAR 
de tres lados	80,3	S	1007889 162,-
	80,3	A	1007890 299,-
	80,3	AM	1008644 299,-
	80,3	VAG	1007891 299,-
de tres lados, macizo	80,3	S	1020645 312,-
de tres lados, macizo	80,3	VAG	1020646 467,-
de cuatro lados	80,3	S	1007760 216,-
	80,3	A	1007761 400,-
	80,3	AM	1008668 400,-
	80,3	VAG	1007762 400,-
de cuatro lados, macizo	80,3	S	1020647 356,-
de cuatro lados, macizo	80,3	VAG	1020648 512,-

Arte Bh-4S 			LINEAR 
de tres lados	80,3	S	1007892 162,-
	80,3	A	1007893 299,-
	80,3	AM	1008645 299,-
	80,3	VAG	1007894 299,-
de tres lados, macizo	80,3	S	1020649 312,-
de tres lados, macizo	80,3	VAG	1020650 467,-
de cuatro lados	80,3	S	1007763 216,-
	80,3	A	1007764 400,-
	80,3	AM	1008669 400,-
	80,3	VAG	1007765 400,-
de cuatro lados, macizo	80,3	S	1020651 356,-
de cuatro lados, macizo	80,3	VAG	1020652 512,-

Arte Bh-3S 			LINEAR 
de tres lados	79,3	S	1008036 139,-
de tres lados, macizo	79,3	S	1020653 312,-
de cuatro lados	79,3	S	1008023 186,-
de cuatro lados, macizo	79,3	S	1020654 356,-

Arte Xh-3S 			LINEAR 
de tres lados	66	S	1008924 139,-
de tres lados, macizo	66	S	1020655 312,-
de cuatro lados	66	S	1008926 186,-
de cuatro lados, macizo	66	S	1020656 356,-

Arte X-FDh-3S 			LINEAR 
de tres lados	66	S	1008925 139,-
de tres lados, macizo	66	S	1020688 312,-
de cuatro lados	66	S	1008927 186,-
de cuatro lados, macizo	66	S	1020689 356,-

Accesorios

Artículo	Denominación	Dimensiones en mm	Precio / N.º de artículo
----------	--------------	-------------------	--------------------------

Carenados

	Para modelos Mini	219,-
	Para modelos Speedy	224,-
	Para modelos Varia	224,-
	Para modelos Arte	224,-

Pintura de retoque

	Pintura de retoque Bote spray de pintura con propulsante libre de FCF		
	Negro	150 ml	19,- 1005111

Parilla

	pequeña	200/160 mm	22,-	1006404
	mediana	220/190 mm	23,-	1006405
	grande	220/220 mm	24,-	1006402
	Linear Varia Ah-2	220/190 mm	25,-	1017907
	Linear Varia ASH-2 / AS-FDh-2	220/150 mm	23,-	1019824

Cenizero

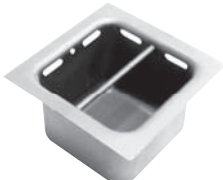
	pequeña	220/150 mm	22,-	1004809
	mediana	220/195 mm	23,-	1008851
	grande	220/220 mm	24,-	1004811
	Linear Varia ASH/AS-FDh-2	215/139 mm	23,-	1021180

Artículo	Denominación	Dimensiones en mm	Precio / N.º de artículo
----------	--------------	-------------------	--------------------------

Mano fría (Llave de regulación aire)

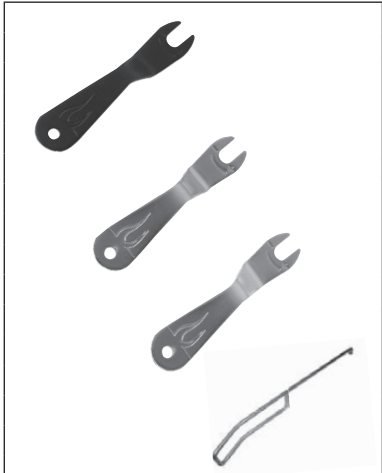
	Standard		13,- 1005057
	Avantgarde		22,- 1006537
	Elegance		22,- 1006536
	Para Linear 3S VAG		22,- 1009118

(en la página 51 encontrará una representación en color de la mano fría)

Pzas. para la conexión del Aire exterior

	De cuadrado a redondo	1 x \varnothing = 150 mm	49,- 1004831
	De cuadrado a redondo	2 x \varnothing = 150 mm	53,- 1004808

Accesorios

Artículo	Denominación	Dimensiones en mm	Precio / N.º de artículo
----------	--------------	-------------------	--------------------------

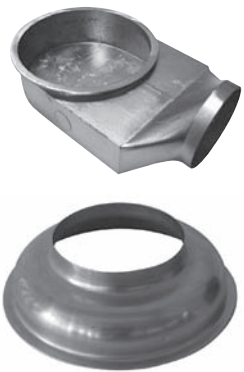

Pza. de conexión para la conexión del aire de combustión exterior

	Pza. de conexión para el aire de combustión exterior con abrazadera, conexión lateral o inferior	1 x \varnothing = 150 mm	114,- 1018173
	Pza. de conexión para el aire de combustión exterior con abrazadera, conexión inferior	1 x \varnothing = 150 mm	58,- 1005229

Marco de montaje: sujeciones

	2 varillas, 2 grapas	29,- 1002277
--	----------------------	---------------------

Bastidor-soporte especial T3S

	Varia C-45h	418,- 1015132
	Varia Ch	454,- 1018367
	Arte U-50h	448,- 1011488
	Arte U-70h	459,- 1009675
	Arte U-90h	472,- 1009676
	Arte 3RL-60h	448,- 1013643
	Arte 3RL-80h	459,- 1013644
	Arte 3RL-100h	472,- 1011035
 Los mecanismos de extensión deber ser pedidos por separado.		

Modelos Mini

Mini R1V 51 + R1Vh 51	1004713	123,-
Mini R1V 57 + R1Vh 57	1004714	137,-
Mini R1V/Z1 51 - 4S	1007552	150,-
Mini R1V/Z1 57 + R1Vh - 4S	1007553	164,-
Mini 2L/2R 51 + 2Lh/2Rh 51, en una pieza	1004716	399,-
Mini 2L/2R 57 + 2Lh/2Rh 57, en una pieza	1004717	417,-
Mini 2L/2R + 2LRh 51 - 4S	1009002	477,-
Mini 2L/2R 57 + 2LRh 57 - 4S	1008151	495,-
Mini S / Sh 51 / S-FDh 51 - 4S	1004711	156,-
Mini Sh 57 / S-FDh 57 - 4S	1009742	180,-
Mini Sh 51 - 3S	1011070	156,-
Mini M1	1010165	115,-
Mini M2	1010166	156,-
Doble Cristal IR - Mini Z1 H ₂ O, XL	1011236	96,-

Modelos Varia

Varia 1V + 1Vh 45	1004744	155,-
Varia 1V + 1Vh 51	1004745	163,-
Varia 1V + 1Vh 57	1004746	217,-
Varia 1V/FD +1Vh/FDh 45 - 4S	1007554	192,-
Varia 1V/FD +1Vh/FDh 51 - 4S	1007555	214,-
Varia 1V/FD +1Vh/FDh 57 - 4S	1007556	236,-
Varia 1Vh + FDh 45 - 3S	1007596	189,-
Varia 1Vh + FDh 51 - 3S	1007597	212,-
Varia 1Vh + FDh 57 - 3S	1007598	234,-
Varia 2L/2R-55h GET-4S	1014507	519,-
Varia 2L/2R + 2Lh/2Rh 51 en una pieza	1004748	454,-
Varia 2L/2R + 2Lh/2Rh 57 en una pieza	1004749	527,-
Varia 2Lh/2Rh 51 - 4S	1008513	535,-
Varia 2Lh/2Rh 57 - 4S	1008514	570,-
Frontal para zum Varia 2L-100h/2R-100h - 4S	1009516	212,-
Lateral para zum Varia 2L-100h/2R-100h - 4S	1009517	92,-
Varia 2LRh/2RRh 51	1004751	527,-
Varia 2LRh/2RRh 57	1004752	576,-
Varia C-45h - 4S	1014016	608,-
Varia Ch - 4S	1004757	1.207,-
Frontal para Varia Ch-4S (tres piezas)	1017666	156,-
Lateral para Varia Ch-4S (tres piezas)	1017667	102,-
Varia Ah	1004755	169,-
Varia Ah/A-FDh - 4S	1007557	235,-
Varia Ah/A-FDh - 3S	1007599	232,-
Varia AS-4S-2	1019822	106,-
Varia AS-4S-2	1019822	106,-
Varia AS-FD-4S-2	1019822	106,-
Varia AS-FDh-4S-2	1019822	106,-
Varia Ah 4S-2 nueva generación	1018006	235,-
Varia Ah 3S-2 nueva generación	1018004	232,-
Varia S/ Varia Sh / Varia G/G04	1006633	234,-
Varia Sh GT - 4S	1007560	279,-
Varia Sh GT - 3S	1007600	269,-
Varia SRh	1008110	353,-
Varia AS	1019822	106,-
Varia Eh - 4S	1004759	437,-
Varia BEh - 4S	1004760	704,-
Varia Bh	1004756	286,-
Varia Bh / B-FDh - 4S	1007558	357,-
Varia Bh / B-FDh - 3S	1007601	357,-
Varia B-120h	1008111	343,-
Varia B-120h - 4S	1007559	368,-
Varia B-120h - 3S	1007602	352,-
Varia M-60h/M-60h GET	1004711	156,-
Varia M-80h/M-80h GET	1008392	213,-
Varia M-100h/M-100h GET	1007558	357,-
Varia 1V/1Vh H ₂ O	1004745	163,-
Varia 1V/1Vh 51 H ₂ O - 4S	1007555	214,-
Varia 1V/1Vh H ₂ O XL/XXL- 4S	1013387	214,-
Doble Cristal IR - Varia 1V H ₂ O XL/XXL	1013388	168,-

Modelos Arte

Arte 1Vh / Sh	1007641	183,-
Arte 1Vh / Sh - 4S	1007550	197,-
Arte Bh	1004699	277,-
Arte Bh / B-FDh - 4S	1007549	314,-
Arte Bh / B-FDh - 3S	1007603	312,-
Arte BRh	1004700	583,-
Arte Xh / Arte X-FDh - 3S	1008506	423,-
Lateral para Arte U-50h - 4S	1011210	145,-
Frontal para Arte U-50h / U-70h - 4S	1009467	130,-
Lateral para Arte U-70h - 4S	1009468	178,-
Frontal para Arte U-90h - 4S	1009375	142,-
Lateral para Arte U-90h - 4S	1009374	222,-
Frontal para Arte 3RL-60h - 4S	1013702	139,-
Lateral para Arte 3RL-60h - 4S	1013701	109,-
Frontal para Arte 3RL-80h - 4S	1013704	175,-
Lateral para Arte 3RL-80h - 4S	1013703	115,-
Frontal para Arte 3RL-100h - 4S	1010302	222,-
Lateral para Arte 3RL-100h - 4S	1010297	156,-
Arte G + Arte O	1004768	1.083,-
Arte Wh - 4S	1010943	823,-

Accesorios Refractarios

Serie	Juego de refractarios						Eboris 1300
	completo	Suelo	Pared				
		I/D	Altura, pared de hogar	45	51	57	
Mini							
Mini R1V/R1Vh		1006598 82,-			1006596 160,-	1006597 183,-	SI
Mini Z1/Z1h		1006622 97,-			1006623 182,-	1006624 195,-	SI
Mini 2L/2R/2LRh		1006602 103,-		1006599 84,-	1006600 84,-	1006601 89,-	SI
Mini S/Sh		1008089 84,-	1008092 137,-				SI
Mini S-FDh		1014343 182,-			1014345 99,-	1014344 106,-	SI
Varia							
Varia 1V/1Vh		1016312 135,-		1016314 177,-	1016313 177,-	1016313 177,-	SI
Varia 2L/2R-55h GET		1017440/1017438 105,-	1017441/1017439 197,-				SI
Varia 2L/2Lh/2R/2Rh		1013406/1006565 140,-		1006561 132,-	1006563 132,-	1006564 132,-	SI
Varia 2L-100h/2R-100h		1014512/1014514 152,-	1014513 164,-				SI
Varia Ah		1006612 179,-	1006611 213,-				SI
Varia Ah-4S-2		1018373 248,-	1018375 243,-				SI
Varia Ah-3S-2		1018374 248,-	1018375 243,-				SI
Varia A-FDh		1008103 174,-	1008102 96,-				Si. Solo suelo
Varia AS/ASh-4S-2		1021267 195,-	1021268 206,-				SI
Varia AS-FD/AS-FDh-4S-2		1021269 245,-	1021270 78,-				SI
Varia Bh hasta 07/12		1006504 152,-	1006506 213,-				SI
Varia Bh a partir de 07/12		1018424 162,-	1018426 336,-				SI
Varia B-FDh		1008105 195,-	1008104 96,-				SI
Varia B-120h hasta 03/11		1008107 178,-	1008106 247,-				SI
Varia B-120h a partir de 03/11		1008107 178,-	1015267 345,-				SI
Varia BEh		1006616 156,-	1006615 239,-				-
Varia Ch		1006620 135,-	1006621 129,-				SI
Varia C-45h	1015354 222,-	1016191 85,-	1016192 139,-				SI
Varia Eh		1006614 145,-	1006613 227,-				-
Varia FD/FDh		1006507 146,-		1008097 99,-	1008098 99,-	1008099 99,-	Si. Solo suelo
Varia M-60h		1016384 114,-	1016385 228,-				SI
Varia M-60h GET		1017442 103,-	1017443 246,-				SI
Varia M-80h		1016393 184,-	1016396 239,-				SI
Varia M-80h GET		1018017 165,-	1018014 287,-				SI
Varia M-100h		1016398 209,-	1016397 302,-				SI
Varia M-100h GET		1018021 184,-	1018022 287,-				SI
Varia S/Sh/GT		1006606 76,-	1006605 153,-				-
Varia Sh a partir de 04/11		1016379 153,-	1016380 243,-				SI

La placa deflectora no está incluida en el suministro

Serie	Juego de refractarios						Eboris 1300
	completo	Suelo	Pared				
		I/D	Altura, pared de hogar	45	51	57	
Arte							
Arte 1Vh		1006594 74,-	1006593 180,-				-
Arte Bh		1006590 85,-	1006588 192,-				-
Arte U-50h		1014317 103,-	1014318 66,-				SI
Arte U-70h		1013257 139,-	1013255 56,-				SI
Arte U-90h		1013258 196,-	1011803 63,-				SI
Arte 3RL-60h	1014336 229,-	1016214 157,-	1016215 75,-				SI
Arte 3RL-80h	1014337 326,-	1016216 192,-	1016217 137,-				SI
Arte 3RL-100h	1010512 364,-	1016218 217,-	1016219 149,-				SI
Arte Xh	1006204 433,-	1016641 197,-	1016643 219,-				SI
Arte X-FDh	1006205 338,-	1016641 197,-	1016642 129,-				SI

La placa deflector no está incluida en el suministro

*Refractario Eboris 1300 - Gris basalto (Con recargo de precio)			
Pedido del hogar con refractario Eboris 1300 en gris 1x precio tarifas del hogar + 1x precio tarifa de un juego de refractario color marfil		Pedido del refractario Eboris 1300 gris por separado (sin hogar) 2x precio tarifa de un juego de refractario color marfil	
<u>Ejemplo:</u> Arte 3RL-60h	4.414,-	<u>Ejemplo:</u> juego de refractario color marfil	229,-
juego de refractario color marfil	229,-	juego de refractario color marfil	229,-

La placa deflector no está incluida en el suministro

Apuntes

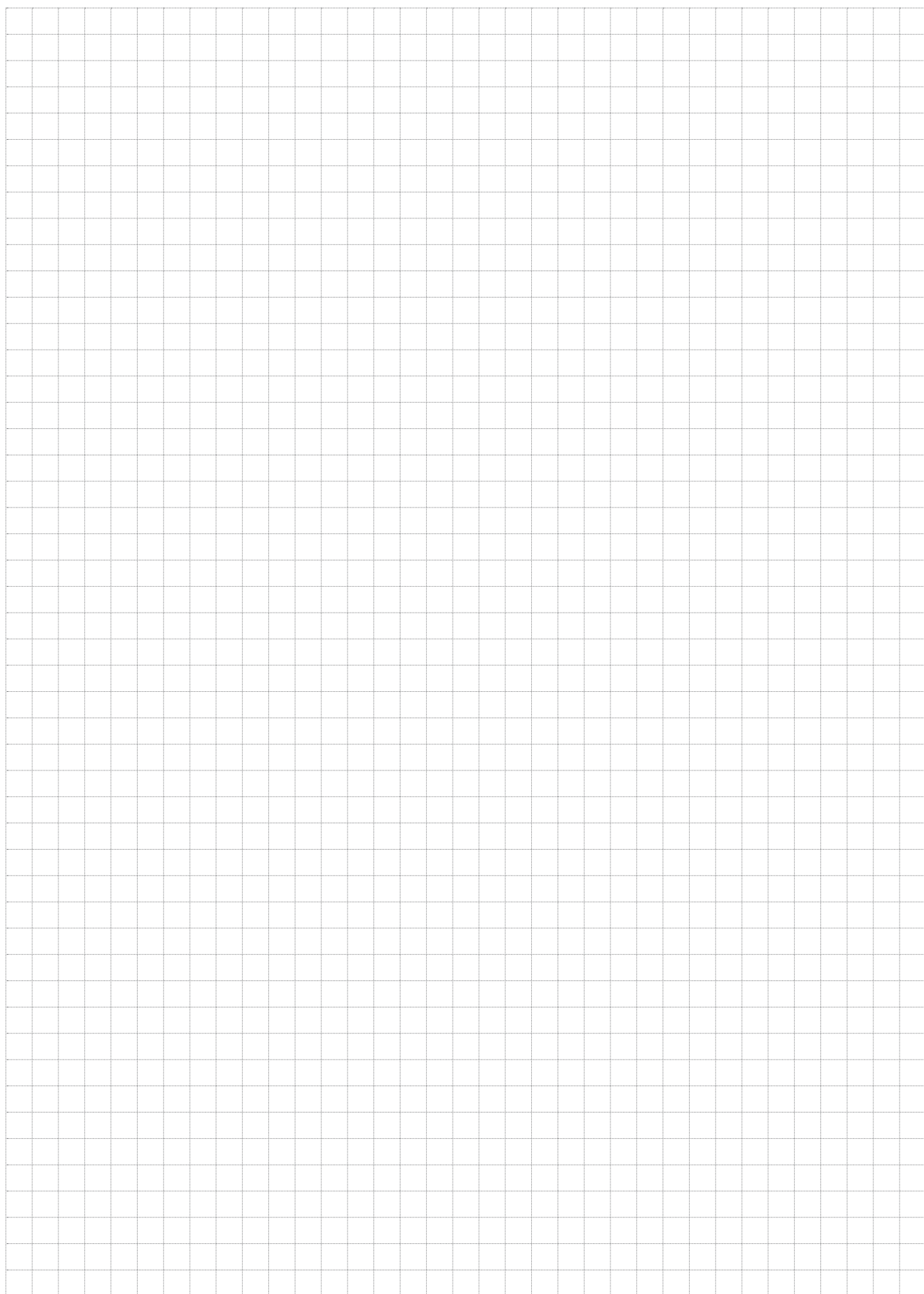

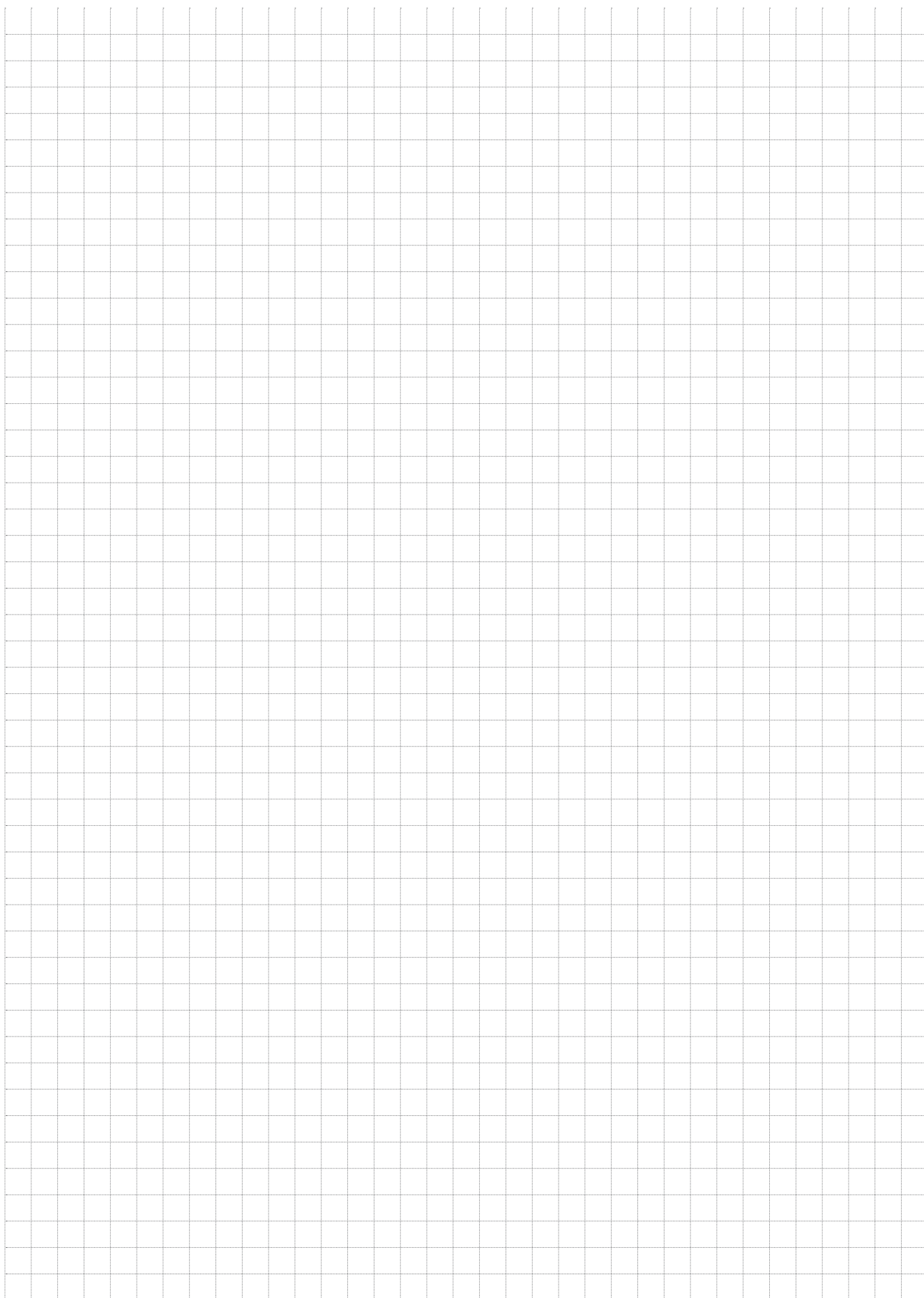

Apuntes

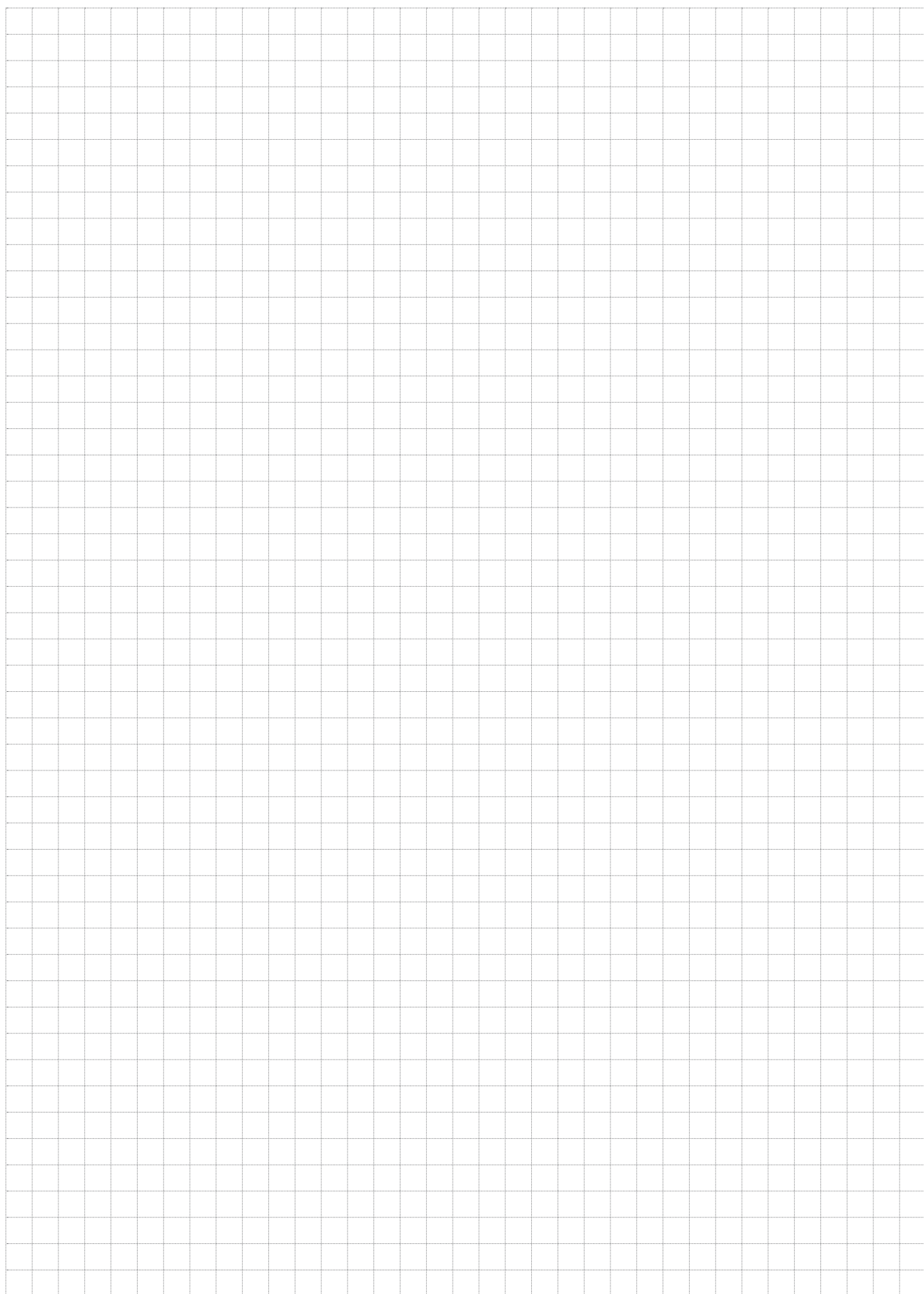

Mano fría (llave de regulación de aire)



Standard

Avantgarde

Elegance

Cassettes a medida - Esquema de funcionamiento

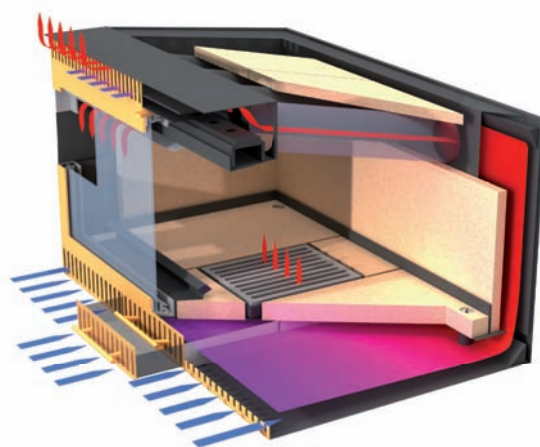

TARIFA DE PRECIOS

