

RADIADORES SECATOALLAS
RADIADORES DE DISEÑO

TOWEL-WARMER RADIATORS
DESIGN RADIATORS

RADIADORES TOALHEIROS
RADIADORES DE DESENHO

Catálogo 2010



 Rodríguez Calderón, S.A.

Toscano Inox	2
Toscano Negro	4
Lugano	6
Tiziano	8
Elba	10
Bali	12
Madeira	14
Bermudas	16
Bermudas Salidas laterales	20
Capri	22
Azores	26
Vulcano	30
Picchio Double	34
Pispola Double	36
Resistencias y Termostatos	38
<i>Resistences and thermostats</i>	
Accesorios	39
<i>Accessories</i>	
Válvulas Radiadores	40
<i>Radiators Valves</i>	

Toscano Inox

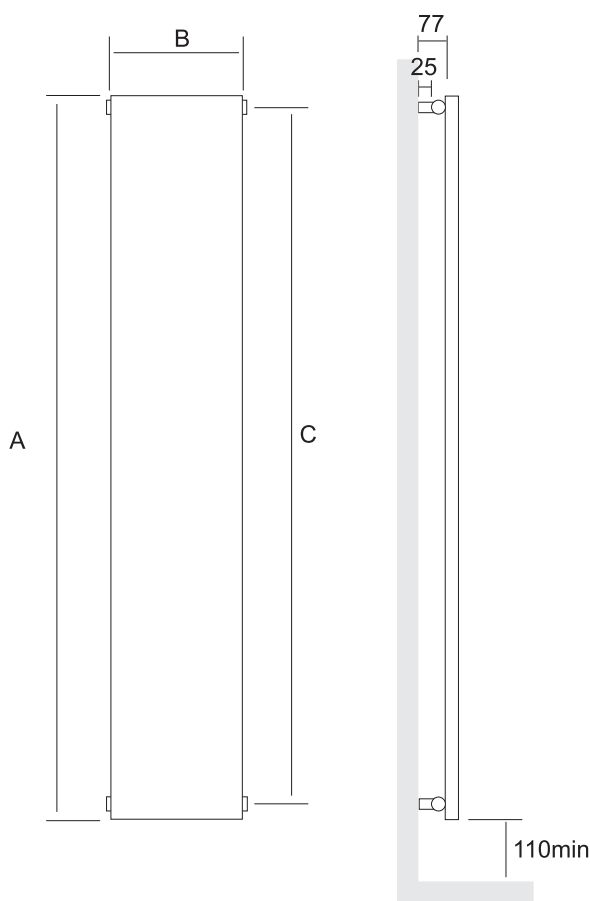

Placa	Rectangular
Rectangular	Plate

Referencia
Reference

Dimensiones en mm./Dimensions in mm.

Potencia / Power
Kcal/h . - Wat/h.

TOS18245I

A	B	C
1804 - 460 - (1740 entre ejes/between axles)		

$\Delta t=50$
844 980

Disponible: acero inoxidable

Available: stainless steel

Versión: calefacción.

Version: heating

Toscano Inox





Toscano Negro

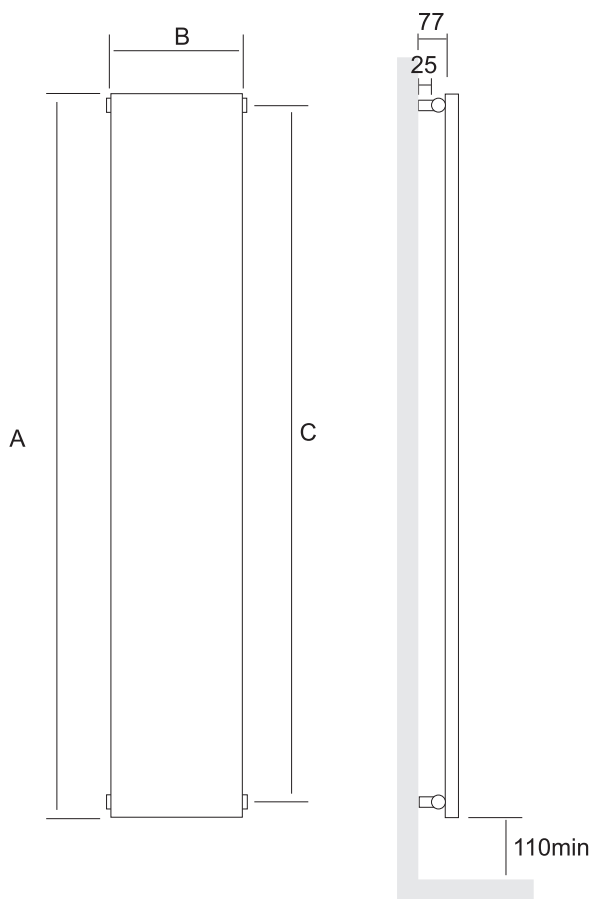

Placa Rectangular
Rectangular Plate

Referencia Reference	Dimensiones en mm./Dimensions in mm.			Potencia / Power Kcal/h . - Wat/h.	
	A	B	C	$\Delta t-50$	
TOS18245N	1804	460	(1740 entre ejes/between axles)	844	980

Disponible: negro

Available: black

Versión: calefacción.

Version: heating



A photograph of a room featuring a blackboard and a whiteboard. The blackboard is mounted on the left wall, and the whiteboard is on the right. In the foreground, a wooden stool holds a stack of books and a small basket. The scene is lit with soft, warm light.

Toscano
Negro

Lugano

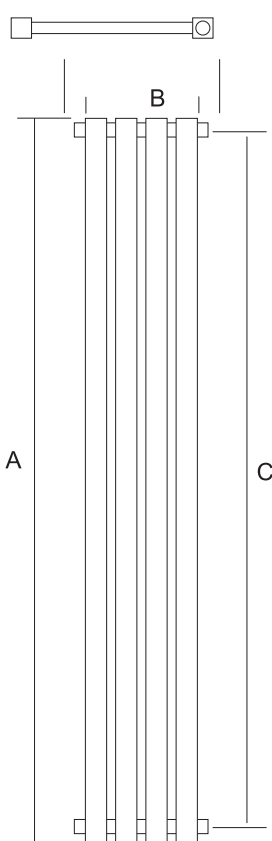

Tubos | Rectangular
Rectangulares | Pipes

□ 68x12mm

Referencia Reference	Dimensiones en mm./Dimensions in mm.			Potencia / Power Kcal/h . - Wat/h.	
	A	B	C	$\Delta t=50$	
LU/D40CR	1810	305	(1760 entre ejes/between axles)	403	468

Disponibile: cromo brillo

Available: bright chrome

Versión: calefacción.

Version: heating.

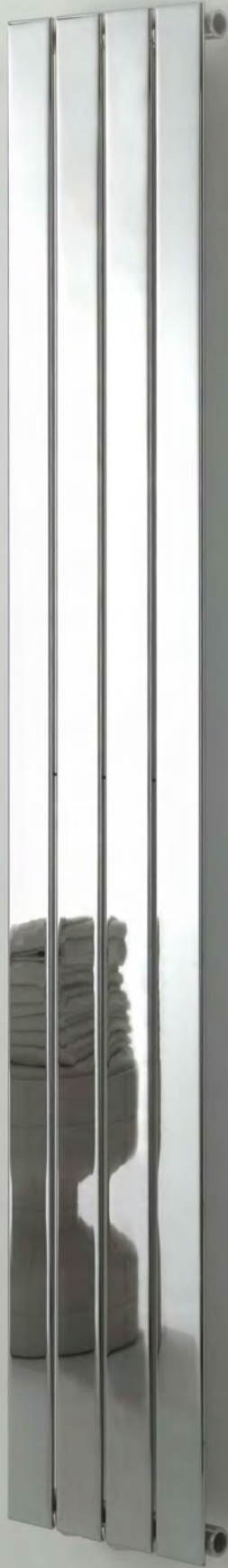

Lugano

Tiziano

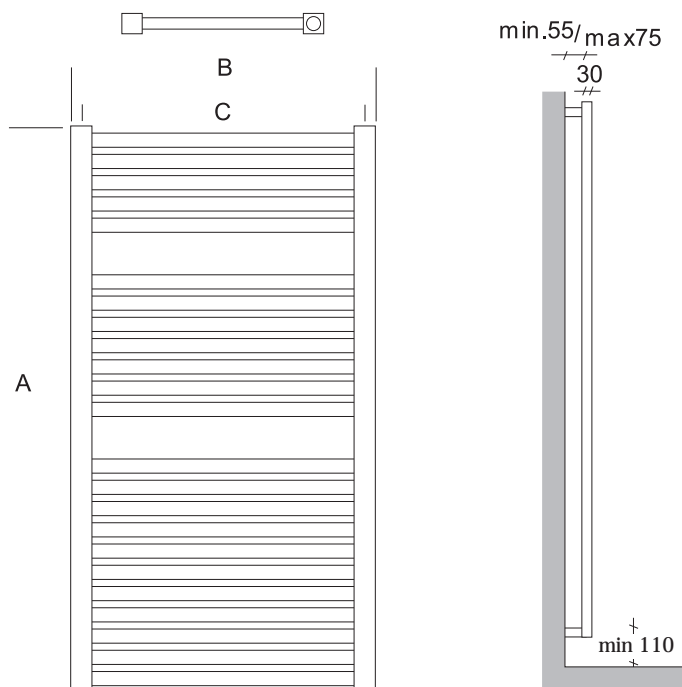

Tubos Radiante
Radiante Pipes
□ 42 x 14 mm

Referencia Dimensiones en cm./Dimensions in mm.
Reference

Potencia/Power
Kcal/h . - Wat/h.
Δt-50

	A	B	C		
T/A50 CR	800	500 (450 entre ejes/between axles)	12 tubos/pipes	254	295
T/B50 CR	1180	500 (450 entre ejes/between axles)	19 tubos/pipes	394	458
T/C50 CR	1600	500 (450 entre ejes/between axles)	24 tubos/pipes	507	589
T/A55 CR	800	550 (500 entre ejes/between axles)	12 tubos/pipes	276	321
T/B55 CR	1180	550 (500 entre ejes/between axles)	19 tubos/pipes	430	499
T/C55 CR	1600	550 (500 entre ejes/between axles)	24 tubos/pipes	552	641

Disponible : Cromo brillo.

Available : Brilliant Chrome.

Versión: calefacción.

Version: Heating.

Opcion: Eléctrico con o sin termostato.

Option: Electric with or without thermostat.

Opción: Mixto (Calefacción+Eléctrico)

Option: Mix (Heating + Electric)

Tiziano



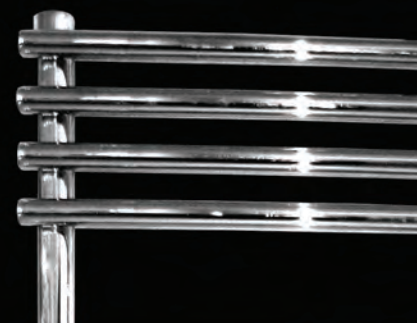

Elba

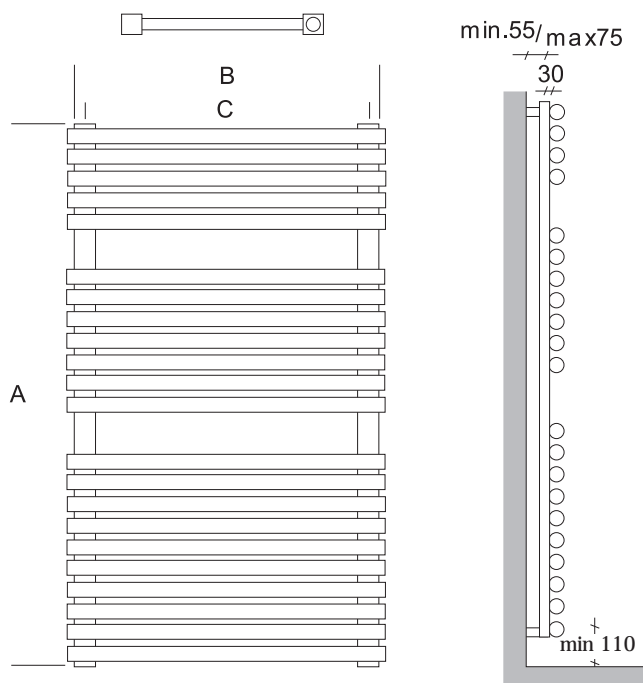

Tubos Radiantes
Radiant Pipes
Ø 22 mm

Referencia Reference	Dimensiones en mm./Dimensions in mm.			Potencia/Power Kcal/h . - Wat/h.	
	A	B	C	Δt-50	
E/A50 CR	800	500	(450 entre ejes/between axles)	15 tubos/pipes	239 278
E/B50 CR	1180	500	(450 entre ejes/between axles)	23 tubos/pipes	363 422
E/C50 CR	1600	500	(450 entre ejes/between axles)	31 tubos/pipes	490 569

Disponible: Cromo Brillo.

Available : Brilliant Chrome.

Versión: calefacción.

Version: Heating.

Opcion: Eléctrico con o sin termostato.

Option: Electric with or without thermostat.

Opción: Mixto (Calefacción + Eléctrico)

Option: Mix (Heating + Electric)

Elba



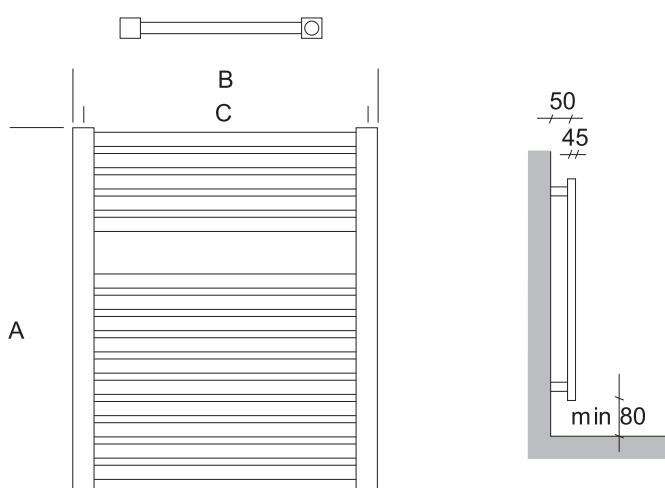
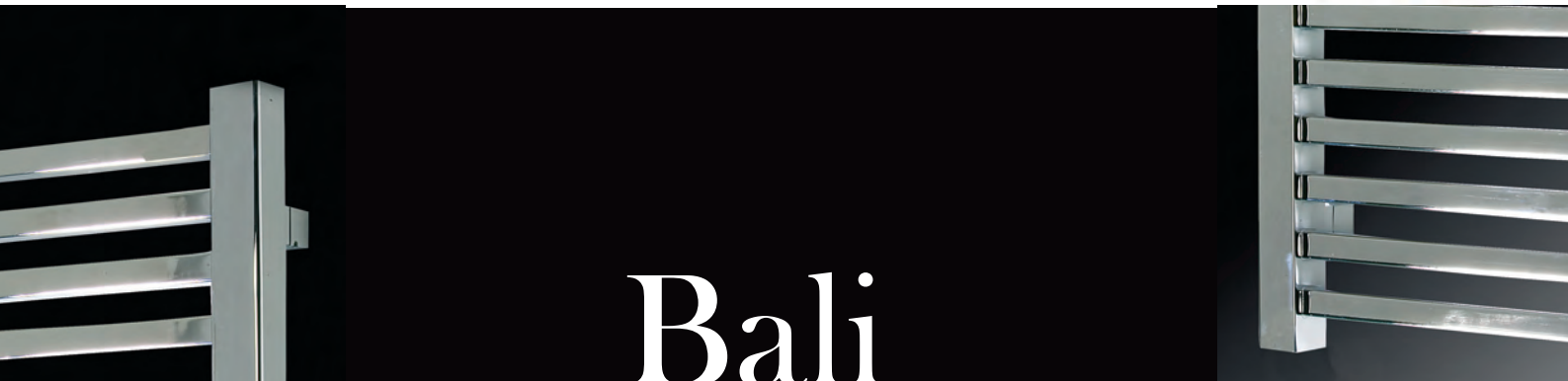

Tubos Radiant
Radiantes Pipes
□ 22 x 22 mm

Referencia Reference	Dimensiones en mm./Dimensions in mm.			Potencia/Power Kcal/h . - Wat/h.	
	A	B	C	Δt-50	
BA/A50 CR	800	500 (450 entre ejes/between axles)	15 tubos/pipes	277	322
BA/B50 CR	1180	500 (450 entre ejes/between axles)	23 tubos/pipes	601	698

Disponible: Cromo Brillo.

Versión: calefacción.

Opcion: Eléctrico con o sin termostato.

Opción: Mixto (Calefacción + Eléctrico)

Available : Brilliant Chrome.

Version: Heating.

Option: Electric with or without thermostat.

Option: Mix (Heating + Electric)

Bali





Madeira

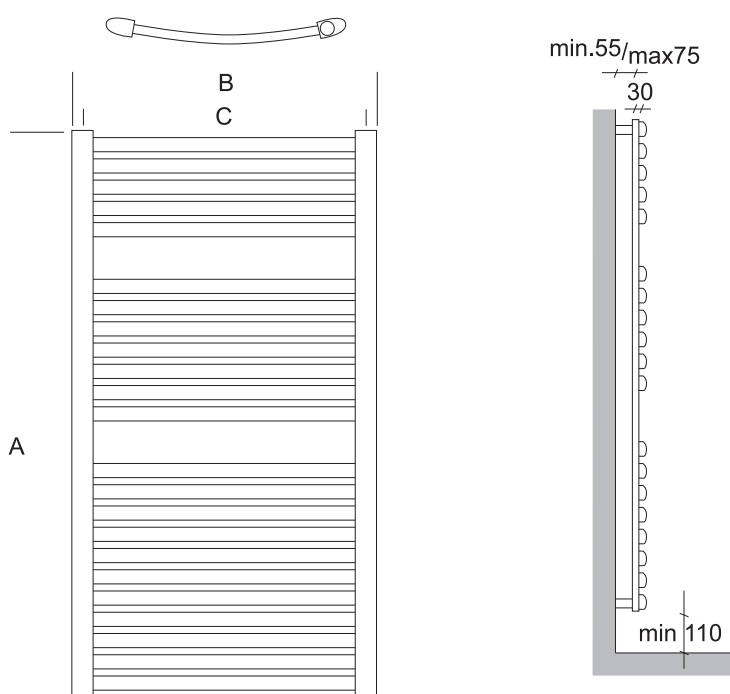

Tubos Curved
Radiantes Radiant
Curvos Pipes
∅ 15 x 30 mm

Referencia Reference	Dimensiones en mm./Dimensions in mm.			Potencia/Power Kcal/h . - Wat/h.	
	A	B	C	Δt-50	
MA/A50 CR	800	500	(450 entre ejes/ between axles)	15 tubos/pipes	237 275
MA/B50 CR	1180	500	(450 entre ejes/between axles)	23 tubos/pipes	358 416

Disponible: Cromo Brillo.

Available : Brilliant Chrome.

Versión: calefacción.

Version: Heating.

Opcion: Eléctrico con o sin termostato.

Option: Electric with or without thermostat.

Opción: Mixto (Calefacción + Eléctrico)

Option: Mix (Heating + Electric)



Madeira

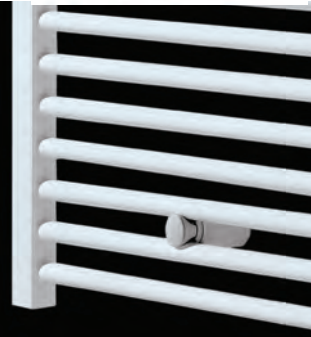

Bermudas

Referencia Reference	Dimensiones en mm./Dimensions in mm.			Potencia/Power Kcal/h. - Wat/h.
	A	B	C	
BE/A45BL	800	450	(400 entre ejes/between axles)	18 tubos/pipes 351 / 408
BE/A50BL	800	500	(450 entre ejes/between axles)	18 tubos/pipes 387 / 449
BE/A55BL	800	550	(500 entre ejes/between axles)	18 tubos/pipes 421 / 489
BE/A60BL	800	600	(550 entre ejes/between axles)	18 tubos/pipes 456 / 530
BE/A65BL	800	650	(600 entre ejes/between axles)	18 tubos/pipes 491 / 570
BE/A100BL	800	1000	(950 entre ejes/between axles)	18 tubos/pipes 632 / 735
BE/B45BL	1180	450	(400 entre ejes/between axles)	27 tubos/pipes 524 / 608
BE/B50BL	1180	500	(450 entre ejes/between axles)	27 tubos/pipes 576 / 669
BE/B55BL	1180	550	(500 entre ejes/between axles)	27 tubos/pipes 628 / 729
BE/B60BL	1180	600	(550 entre ejes/between axles)	26 tubos/pipes 680 / 790
BE/B65BL	1180	650	(600 entre ejes/between axles)	26 tubos/pipes 641 / 745
BE/B75BL	1180	750	(700 entre ejes/between axles)	26 tubos/pipes 741 / 862
BE/B100BL	1180	1000	(950 entre ejes/between axles)	26 tubos/pipes 974 / 1132
BE/C45BL	1500	450	(400 entre ejes/between axles)	32 tubos/pipes 633 / 735
BE/C50BL	1500	500	(450 entre ejes/between axles)	32 tubos/pipes 695 / 807
BE/C55BL	1500	550	(500 entre ejes/between axles)	32 tubos/pipes 757 / 879
BE/C60BL	1500	600	(550 entre ejes/between axles)	32 tubos/pipes 819 / 951
BE/C75BL	1500	750	(700 entre ejes/between axles)	32 tubos/pipes 899 / 1045
BE/D45BL	1810	450	(400 entre ejes/between axles)	40 tubos/pipes 714 / 830
BE/D50BL	1810	500	(450 entre ejes/between axles)	40 tubos/pipes 860 / 998
BE/D55BL	1810	550	(500 entre ejes/between axles)	40 tubos/pipes 937 / 1088
BE/D60BL	1810	600	(550 entre ejes/between axles)	40 tubos/pipes 918 / 1067
BE/D65BL	1810	650	(600 entre ejes/between axles)	40 tubos/pipes 951 / 1105
BE/D100BL	1810	1000	(950 entre ejes/between axles)	40 tubos/pipes 1459 / 1697

Tubos Radiantes
Radiant Pipes
Ø 25 mm

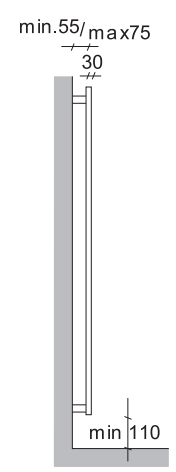
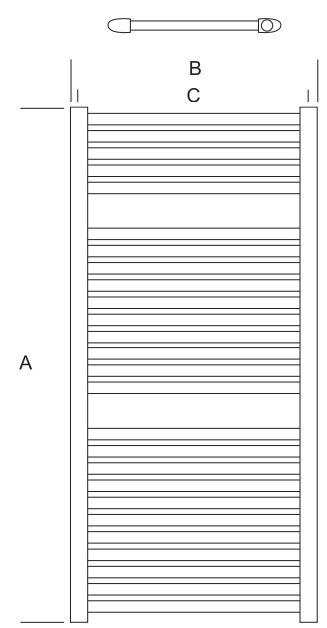

Disponible: Blanco.

Available: White.

Versión: calefacción.

Version: Heating.

Opcion: Eléctrico con o sin termostato

Option: Electric with or without thermostat.

Opción: Mixto (Calefacción + Eléctrico)

Option: Mix (Heating + Electric)



Bermudas



Bermudas

Referencia Reference	Dimensiones en mm./Dimensions in mm.			Potencia/Power Kcal/h. - Wat/h.	Tubos Radiantes	Radiant Pipes
	A	B	C			
BE/A45CR	800	- 450	(400 entre ejes/between axles)	18 tubos/pipes	245 / 285	
BE/A50CR	800	- 500	(450 entre ejes/between axles)	18 tubos/pipes	270 / 313	
BE/A55CR	800	- 550	(500 entre ejes/between axles)	18 tubos/pipes	295 / 343	
BE/A60CR	800	- 600	(550 entre ejes/between axles)	17 tubos/pipes	298 / 347	
BE/A65CR	800	- 650	(600 entre ejes/between axles)	17 tubos/pipes	306 / 359	
BE/A75CR	800	- 750	(700 entre ejes/between axles)	17 tubos/pipes	364 / 423	
BE/A100CR	800	- 1000	(950 entre ejes/between axles)	17 tubos/pipes	474 / 551	
BE/B45CR	1180	- 450	(400 entre ejes/between axles)	27 tubos/pipes	367 / 426	
BE/B50CR	1180	- 500	(450 entre ejes/between axles)	27 tubos/pipes	404 / 469	
BE/B55CR	1180	- 550	(500 entre ejes/between axles)	27 tubos/pipes	440 / 511	
BE/B60CR	1180	- 600	(550 entre ejes/between axles)	26 tubos/pipes	477 / 554	
BE/B65CR	1180	- 650	(600 entre ejes/between axles)	26 tubos/pipes	480 / 558	
BE/B75BL	1180	- 750	(700 entre ejes/between axles)	26 tubos/pipes	555 / 646	
BE/B100CR	1180	- 1000	(950 entre ejes/between axles)	26 tubos/pipes	730 / 849	
BE/C45CR	1500	- 450	(400 entre ejes/between axles)	32 tubos/pipes	442 / 513	
BE/C50CR	1500	- 500	(450 entre ejes/between axles)	32 tubos/pipes	486 / 564	
BE/C55CR	1500	- 550	(500 entre ejes/between axles)	32 tubos/pipes	529 / 614	
BE/C60CR	1500	- 600	(550 entre ejes/between axles)	32 tubos/pipes	573 / 665	
BE/C65CR	1500	- 650	(600 entre ejes/between axles)	32 tubos/pipes	568 / 661	
BE/C100CR	1500	- 1000	(950 entre ejes/between axles)	32 tubos/pipes	874 / 1017	
BE/D45CR	1810	- 450	(400 entre ejes/between axles)	40 tubos/pipes	535 / 622	
BE/D50CR	1810	- 500	(450 entre ejes/between axles)	40 tubos/pipes	586 / 681	
BE/D65CR	1810	- 650	(600 entre ejes/between axles)	40 tubos/pipes	713 / 753	
BE/D100CR	1810	- 1000	(950 entre ejes/between axles)	40 tubos/pipes	1094 / 1272	

Tubos
Radiantes

Radiant
Pipes

Ø 25 mm

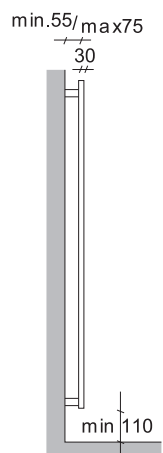
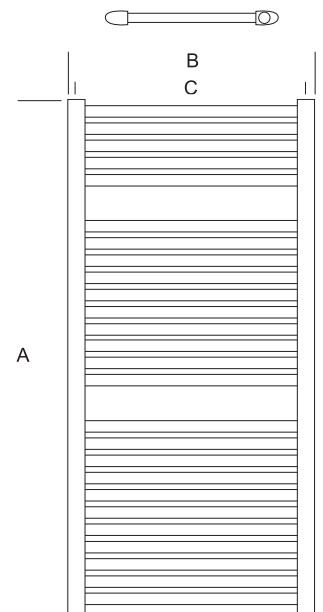

Disponible: Cromo brillo

Versión: calefacción.

Opcion: Eléctrico con o sin termostato

**Opción: Mixto
(Calefacción+ Eléctrico)**

Available: Brilliant chrome

Version: Heating.

Option: Electric with or without thermostat.

**Option: Mix
(Heating + Electric)**



Bermudas



Bermudas SL

Tubos Radiantes | Radiant Pipes

Ø 25 mm

Referencia Reference	Dimensiones en mm./Dimensions in mm.			Potencia/Power Kcal/h. - Wat/h.	
	A	B	C	Δt-50	
BLANCO					
BS/A45BL	800	- 450 (400 entre ejes/between axles)	17 tubos	311	/ 362
BS/A50BL	800	- 500 (450 entre ejes/between axles)	17 tubos	387	/ 449
BS/A55BL	800	- 550 (500 entre ejes/between axles)	17 tubos	370	/ 430
BS/A60BL	800	- 600 (550 entre ejes/between axles)	17 tubos	398	/ 463
BS/B45BL	1180	- 450 (400 entre ejes/between axles)	26 tubos	463	/ 538
BS/B50BL	1180	- 500 (450 entre ejes/between axles)	26 tubos	576	/ 669
BS/B55BL	1180	- 550 (500 entre ejes/between axles)	26 tubos	556	/ 646
BS/B60BL	1180	- 600 (550 entre ejes/between axles)	26 tubos	602	/ 700
BS/B65BL	1180	- 650 (600 entre ejes/between axles)	26 tubos	745	/ 641
BS/B75BL	1180	- 750 (700 entre ejes/between axles)	26 tubos	741	/ 862
BS/C60BL	1500	- 600 (550 entre ejes/between axles)	32 tubos	738	/ 858
BS/C75BL	1500	- 750 (700 entre ejes/between axles)	32 tubos	899	/ 1045

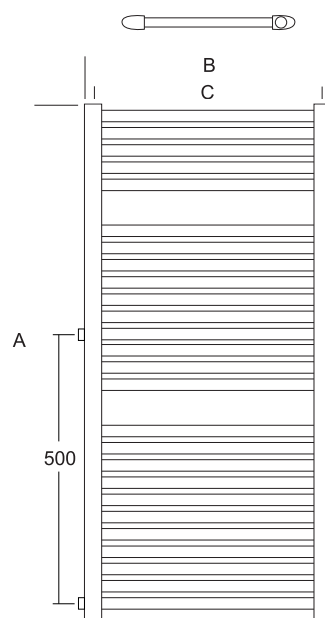

Disponible: Blanco

Available : White

Versión: calefacción.

Version: Heating.

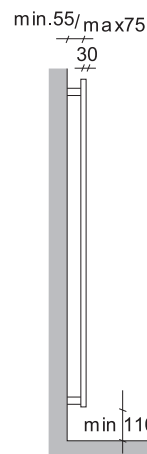



Bermudas SL



Capri

Tubos Curved
Radiantes Radiant
Curvados Pipes

Ø 25 mm

Referencia
Reference

Dimensiones en mm./Dimensions in mm.

A B C

C/A45BL	800 - 450 (400 entre ejes/between axles)	/ 17 tubos/pipes
C/A50BL	800 - 500 (452 entre ejes/between axles)	/ 17 tubos/pipes
C/A55BL	800 - 550 (500 entre ejes/between axles)	/ 17 tubos/pipes
C/A60BL	800 - 600 (552 entre ejes/between axles)	/ 17 tubos/pipes
C/B45BL	1180 - 450 (402 entre ejes/between axles)	/ 26 tubos/pipes
C/B50BL	1180 - 500 (452 entre ejes/between axles)	/ 26 tubos/pipes
C/B55BL	1180 - 550 (502 entre ejes/between axles)	/ 26 tubos/pipes
C/B60BL	1180 - 600 (552 entre ejes/between axles)	/ 26 tubos/pipes
C/C45BL	1505 - 450 (402 entre ejes/between axles)	/ 32 tubos/pipes
C/C50BL	1505 - 500 (452 entre ejes/between axles)	/ 32 tubos/pipes
C/C60BL	1505 - 600 (552 entre ejes/between axles)	/ 32 tubos/pipes
C/D45BL	1815 - 450 (402 entre ejes/between axles)	/ 40 tubos/pipes
C/D50BL	1815 - 500 (452 entre ejes/between axles)	/ 40 tubos/pipes
C/D55BL	1815 - 550 (502 entre ejes/between axles)	/ 40 tubos/pipes
C/D60BL	1815 - 600 (552 entre ejes/between axles)	/ 40 tubos/pipes

Potencia/Power
Kcal/h.- Wat/h.

Δt-50

310	361
373	433
407	473
413	481
464	540
564	655
617	716
629	732
580	675
699	812
789	918
732	852
803	934
872	1015
943	1097

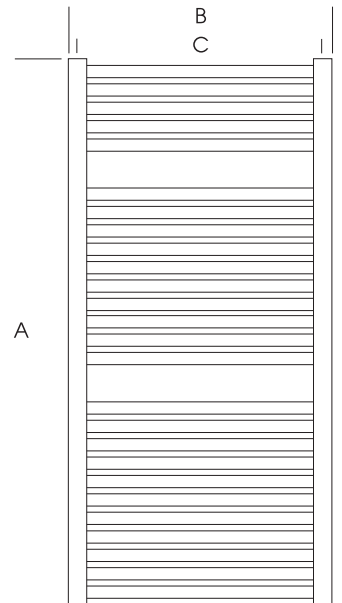
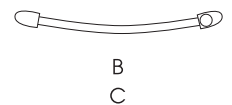
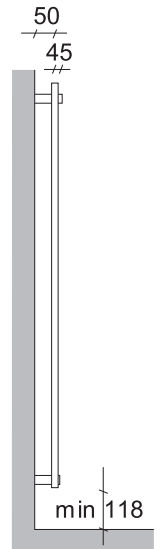

Disponible: Blanco.

Available: White.

Versión: calefacción.

Version: Heating.

Opcion: Eléctrico con o sin termostato.

Option: Electric with or without thermostat.

Opción: Mixto (Calefacción + Eléctrico)

Option: Mix (Heating + Electric)



Capri



Capri

Tubos Curved
Radiantes Radiant
Curvados Pipes

Referencia Reference	Dimensiones en mm./Dimensions in mm.			Potencia/Power Kcal/h.- Wat/h.	
	A	B	C	$\Delta t=50$	
C/A45CR	800	- 450 (400 entre ejes/between axles)	/ 17 tubos/pipes	232	270
C/A50CR	800	- 500 (452 entre ejes/between axles)	/ 17 tubos/pipes	261	303
C/A55CR	800	- 550 (500 entre ejes/between axles)	/ 17 tubos/pipes	285	331
C/A60CR	800	- 600 (552 entre ejes/between axles)	/ 17 tubos/pipes	309	360
C/B45CR	1180	- 450 (402 entre ejes/between axles)	/ 26 tubos/pipes	348	405
C/B50CR	1180	- 500 (452 entre ejes/between axles)	/ 26 tubos/pipes	394	458
C/B55CR	1180	- 550 (502 entre ejes/between axles)	/ 26 tubos/pipes	431	500
C/C45CR	1505	- 450 (402 entre ejes/between axles)	/ 32 tubos/pipes	435	506
C/C50CR	1505	- 500 (452 entre ejes/between axles)	/ 32 tubos/pipes	489	568
C/C55CR	1505	- 550 (500 entre ejes/between axles)	/ 32 tubos/pipes	539	627
C/C60CR	1505	- 600 (552 entre ejes/between axles)	/ 32 tubos/pipes	591	688
C/D45CR	1815	- 450 (402 entre ejes/between axles)	/ 40 tubos/pipes	549	639
C/D50CR	1815	- 500 (452 entre ejes/between axles)	/ 40 tubos/pipes	602	700
C/D55CR	1815	- 550 (502 entre ejes/between axles)	/ 40 tubos/pipes	654	761
C/D60CR	1815	- 600 (552 entre ejes/between axles)	/ 40 tubos/pipes	707	822

Ø 25 mm

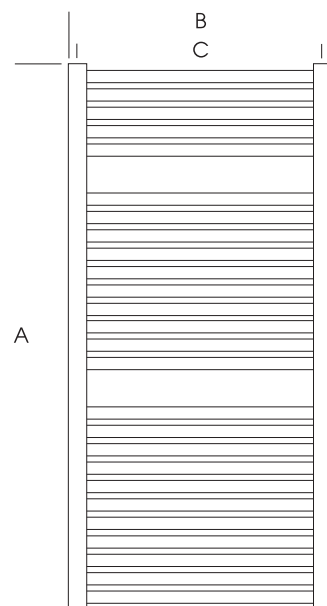
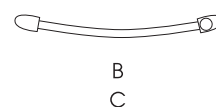
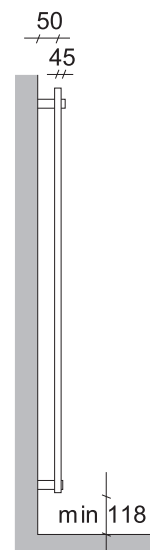

Disponible: Cromo Brillo.

Available: Brilliant Chrome.

Versión: calefacción.

Version: Heating.

Opcion: Eléctrico con o sin termostato.

Option: Electric with or without thermostat.

Opción Mixto (Calefacción + Eléctrico)

Option: Mix (Heating + Electric)



Capri



Azores

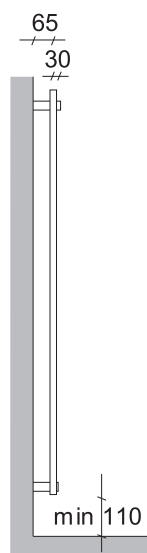
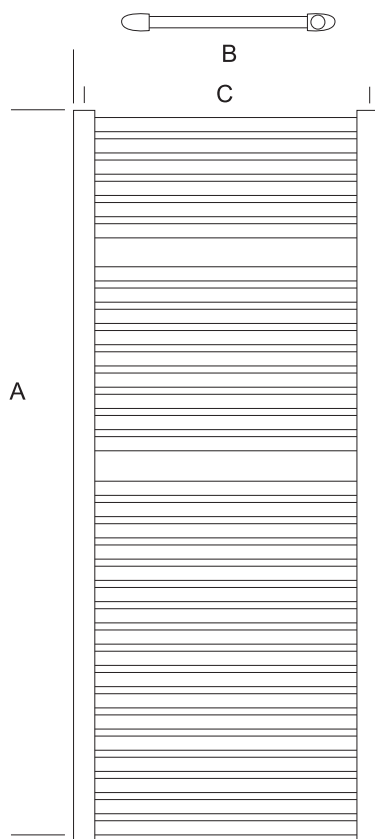

Tubos Radiantes | Radiant Pipes
 Ø 20 mm

Referencia
Reference

Dimensiones en mm./Dimensions in mm.
 A B C

Potencia/Power
Kcal/h . - Wat/h.
 Δt-50

AZ/A50 BL	800 - 500 (450 entre ejes/between axles)	/ 17 tubos/pipes	292	339
AZ/B50 BL	1180 - 500 (450 entre ejes/between axles)	/ 27 tubos/pipes	450	523
AZ/C50 BL	1500 - 500 (450 entre ejes/between axles)	/ 32 tubos/pipes	546	634

Disponible: Blanco.

Available : White.

Versión: calefacción.

Version: Heating.

Opcion: Eléctrico con o sin termostato

Option: Electric with or without thermostat.

Opción: Mixto (Calefacción + Eléctrico)

Option: Mix (Heating + Electric)



Azores



Azores

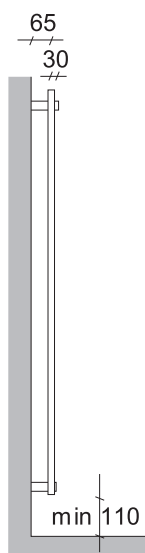
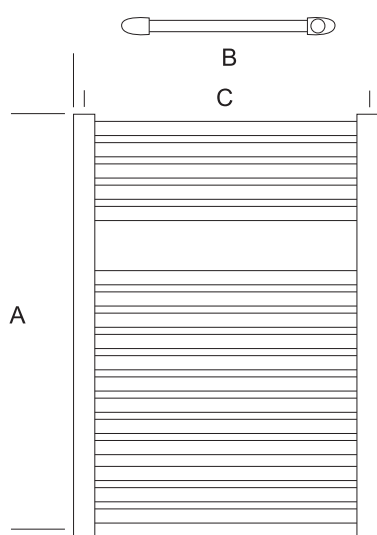

Tubos Radiantes
Radiantes Pipes
Ø 20 mm

Referencia Reference	Dimensiones en mm./Dimensions in mm.			Potencia/Power Kcal/h . - Wat/h.		
	A	B	C	$\Delta t=50$		
AZ/A50 CR	800	500	(450 entre ejes/between axles)	17 tubos/pipes	204	237

Disponible: Cromo Brillo.

Versión: calefacción.

Opcion: Eléctrico con o sin termostato

Opción: Mixto (Calefacción + Eléctrico)

Available : Chrome.

Version: Heating.

Option: Electric with or without thermostat.

Option: Mix (Heating + Electric)



Azores



Vulcano

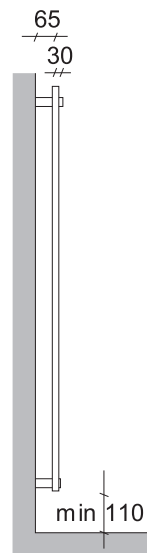
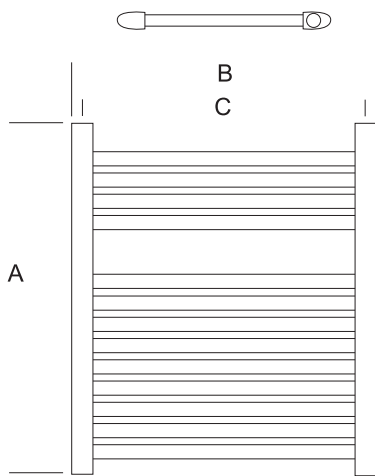

Tubos Radiant
Radiantes Pipes
Ø 20 mm

Referencia Reference	Dimensiones en mm./Dimensions in mm.			Potencia/Power Kcal/h . - Wat/h.	
	A	B	C	Δt-50	
V/A50BL	700	500 (450 entre ejes/between axles)	13 tubos/pipes	234	272

Disponible: Blanco.

Versión: calefacción.

Opcion: Eléctrico con o sin termostato

Opción: Mixto (Calefacción + Eléctrico)

Available : White.

Version: Heating.

Option: Electric with or without thermostat.

Option: Mix (Heating + Electric)



Vulcano



Vulcano

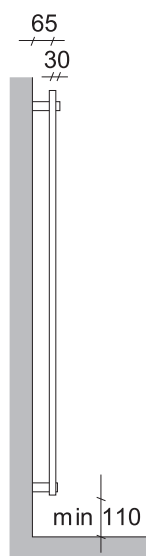
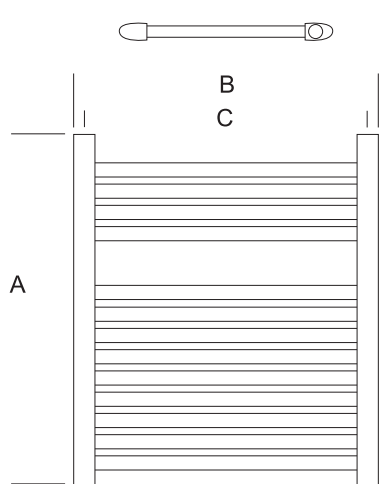

Tubos Radiant
Radiantes Pipes
Ø 20 mm

Referencia Reference	Dimensiones en mm./Dimensions in mm.		
	A	B	C
V/A50CR	700 - 500 (450 entre ejes/between axles) / 13 tubos/pipes		

Potencia/Power Kcal/h . - Wat/h.	
Δt-50	
164	190

Disponible: Cromo.

Versión: calefacción.

Opcion: Eléctrico con o sin termostato

Opción: Mixto (Calefacción + Eléctrico)

Available : Chrome.

Version: Heating.

Option: Electric with or without thermostat.

Option: Mix (Heating + Electric)



Vulcano

Picchio Double

Código Code	Nº de elementos Nº elements	Ancho (L) Width	Altura (H) Height	1010	1210
				entre centro (I) between axles	
				960	1160
				Pot. Térmica/wat Thermal Power/wat	
PC08D	08	605		1011	1188
PC09D	09	680		1138	1336

Medidas en milímetros/Measures in mm.

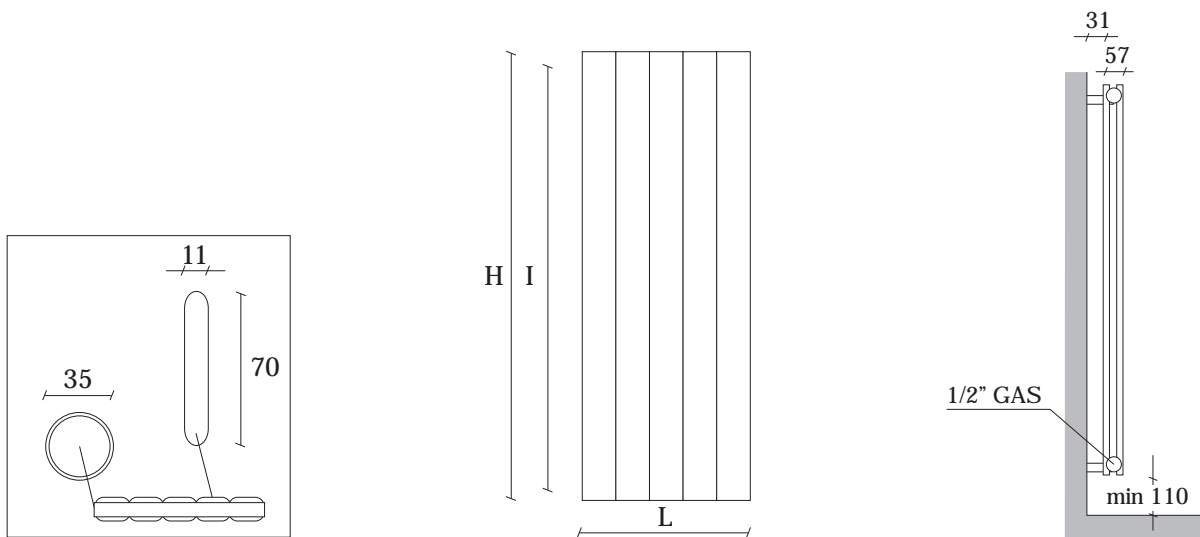

**COLORES DISPONIBLES
AVAILABLE COLORS**

ROJO/RED	NEGRO/BLACK	PERGAMON	ROYAL BLUE

Consulten para otras medidas y colores
Consult for other measures and colors



Picchio Double

Pispola Double

Código Code	Nº de elementos Nº elements	Altura (H) Height	Ancho (L) Width	1010
entre centro/between axles (I) 960				
Pot. Térmica/wat/Thermal power/wat				
PS08D	08	605		1001
PS09D	09	680		1126

Medidas en milímetros/Measures in mm.

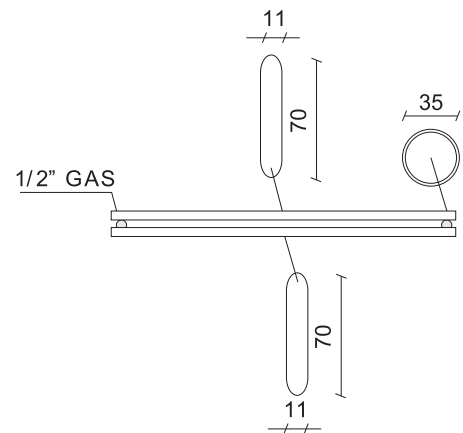
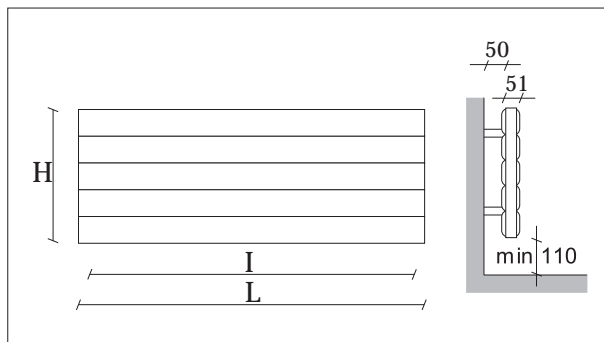

COLORES DISPONIBLES AVAILABLE COLORS



Consulten para otras medidas y colores.
Consult for other measures an colors.



Pispola Double

Resistencias y Termostatos

RESISTENCIAS

CE

Resistencias sin termostato / Resistance without thermostat

- 350 W Para radiadores altura 77/80 / For radiators height 77/80
- 650 W Para radiadores altura 118/123 / For radiators height 118/123
- 900 W Para radiadores altura 150/181 / For radiators height 150/181



CE

Resistencias para termostato/ Resistance for thermostat

- 350 W Para radiadores altura 77/80 / For radiators height 77/80
- 650 W Para radiadores altura 118/123 / For radiators height 118/123
- 900 W Para radiadores altura 150/181 / For radiators height 150/181



CE



Termostato para radiadores blancos / Thermostat for white radiators



Termostato para radiadores cromados / Thermostat for chromed radiators

CARACTERÍSTICAS TÉCNICAS TERMOSTATOS

	Radiadores Cromo	Radiadores Blancos
Modelo del termostato/ Thermostat model	POSEIDONE-1	TH-SPX
Potencia de Suministro/Power supply	230V 10% 50Hz	
Máxima potencia de calentamiento del elemento/Max heating element power	2.000W	
Clase de aislamiento/Insulation class	1	
Clase de protección al agua/Water protection class	IPX4	
Caja de protección de impactos/Box impacts protection	IK09	IK04
Temperatura de funcionamiento/Operating temperature	0°C ----50°C	
Temperatura de almacenamiento/Storage temperature	-20°C ----+70°C	
Humedad de funcionamiento/Operating humidity	0 --- 85% sin condensación	
Regulación/Regulation	Proporcional e integral	ON/OFF (hystéresis)
Fijación de la temperatura/Temperature setting	Analógico	
Rango de fijación de temperatura/Temperature range setting	7°C, 15-30°C	
Resolución de temperatura/Temperature resolution	1/16°C	1/10°C

Accesorios

Toalleros para radiador Toscano

/towel bar for Toscano radiator

Disponible en **Cromado**

/Available in Chromed colour



Toallero cromado recto para radiador secatoallas

/Straight towel bar for towel warmer.

Disponible para radiadores de 45cm y 50cm entre ejes.

/Available for radiators of 45cm and 50cm between axles

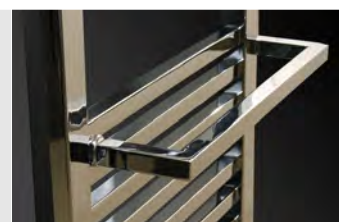

Toallero cromado curvo para radiador secatoallas

/Curved towel bar for towel warmer.

Disponible para radiadores de 45cm y 50cm entre ejes.

/Available for radiators of 45cm and 50cm between axles

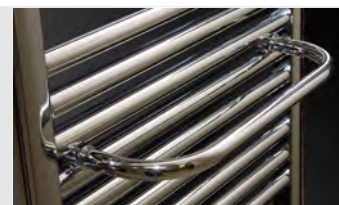

Perchas cromadas

/Chromed hangers

Blister de 2 unidades

/2 units in blister

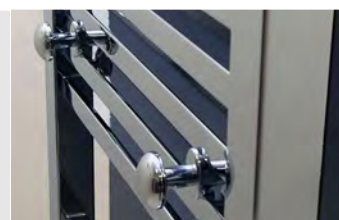

Kit conexión 1/2" Tuerca de 1/2" 100 x Ø15

/ Connection kit 1/2"

(Contenido: 2 UNIDADES)

/ (Content: 2 UNITS)



Cubre tubos cromado/ Chromed cover pipe

Válido para tubos de cobre Ø15, Multicapa Ø16, PEX Ø16

Available for cooper Ø15, Multilayer Ø16, PEX Ø16 pipes.

(Contenido: 2 UNIDADES)/ (Content: 2 UNITS)

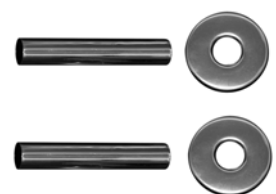

Racor Conexión Tubo Cobre Ø15

/ Connection cooper pipe Ø15 (Contenido: 2 UNIDADES)/ (Content: 2 UNITS)



Racor Conexión Tubo Multicapa Ø16

/ Connection Multilayer pipe Ø16 (Contenido: 2 UNIDADES)/ (Content: 2 UNITS)



Kit Válvula Radiador y Detentor

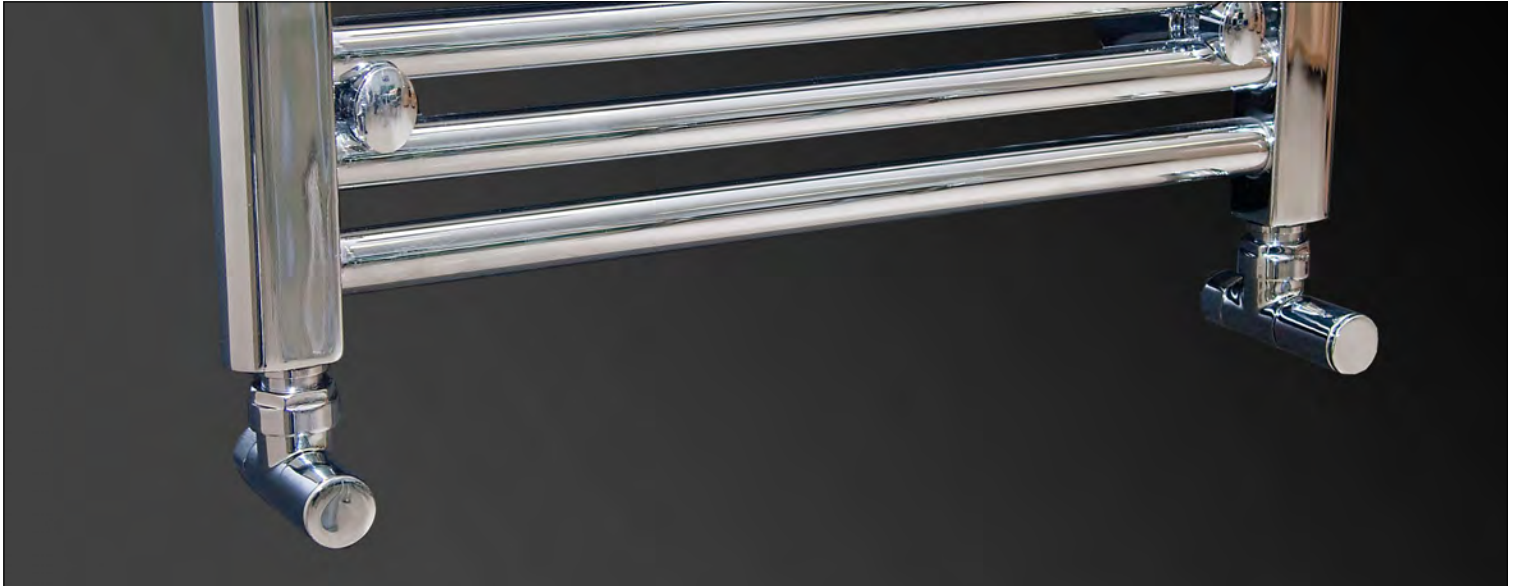

Componentes/ Components:

REF: VRYD

Detentor Cromado 1/2" x 1/2"
/Chromed Holder

Válvula Radiador Cromada 1/2" x 1/2"
/Chromed Radiator Valve

Racor Conexión Tubo Cobre Ø 15
(2 unidades)
/Connection copper pipe Ø 15
(2 units)

Kits de conexión Incluidos: Connection kits Included:



Racor Conexión Tubo Multicapa / Pex Ø 16
(2 unidades)
/Connection Multilayer / Pex pipe Ø 16
(2 units)

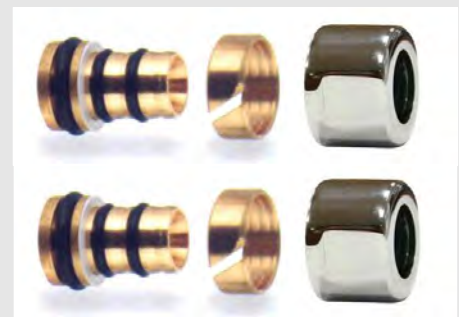

Kit Válvula Termostática y Detentor angular con cabezal

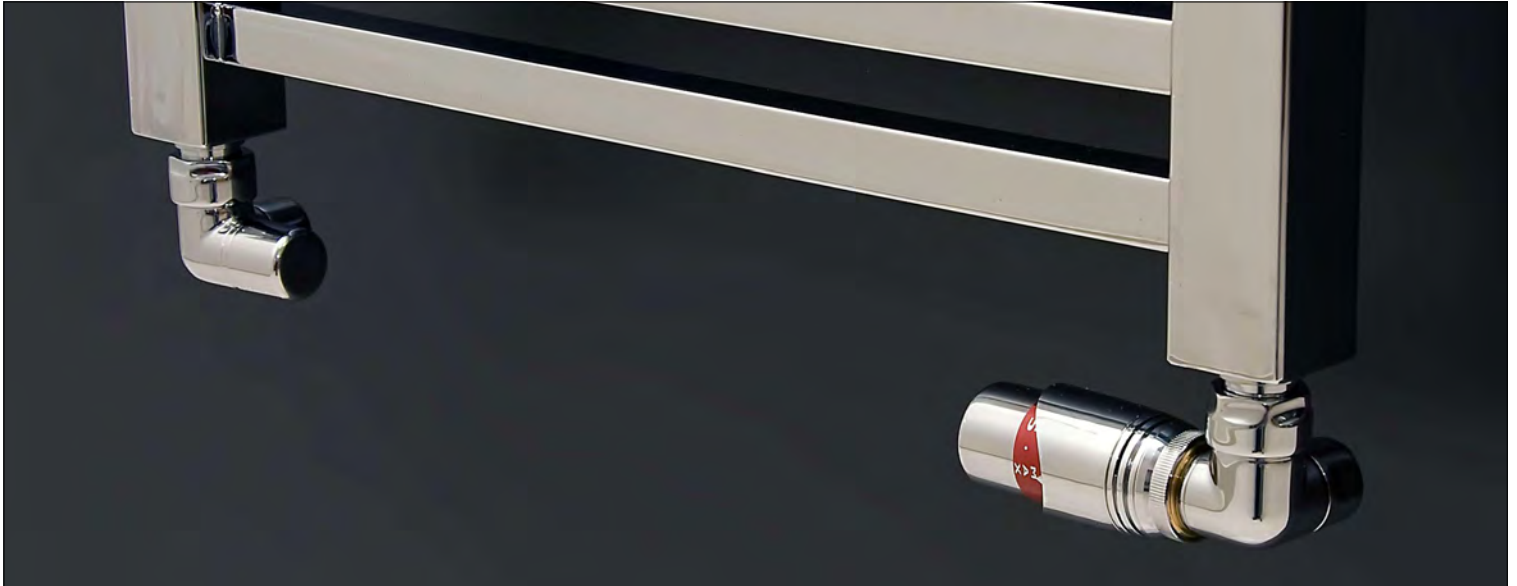

Componentes/ Components:

REF: VRTAYD

Detentor Angular Cromado 1/2" x 1/2"
/Chromed Angular Holder

Válvula Angular Cromada 1/2" x 1/2"
/Chromed Angular Valve

Cabezal Termostático
/Thermostatic head

Kits de conexión Incluidos:
Connection kits Included:

Racor Conexión Tubo Cobre Ø15 (2 unidades)
/Connection copper pipe Ø15 (2 units)



Racor Conexión Tubo Multicapa / Pex Ø16
(2 unidades)
/Connection Multilayer / Pex pipe Ø16
(2 units)

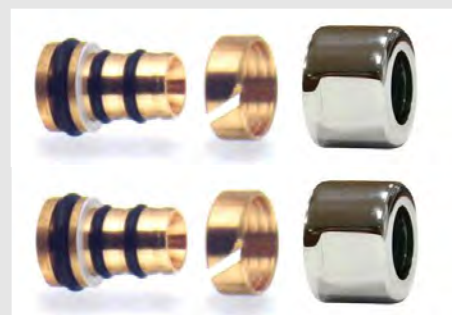

**RADIADORES Y SECATOALLAS
TOWELS - WARMER/RADIATORS**

TARIFA 2010



Rodríguez Calderón, S.A.



Toscano

Color Negro

ACERO INOX
BRILLANTE

Referencia	Medida			P.V.P.	P.V.P.
	Alto	Ancho	E-Ejes		
T/18245	1804	460	1760	458 €	458 €
TOALLERO BARRA	60	41'5	—		59 €

Lugano

Blanco

Cromo

Referencia	Medida			P.V.P.	P.V.P.
	Alto	Ancho	E-Ejes		
LU/D40 CR	1810	305	1760	—	392 €

Tiziano

Blanco

Cromo

Referencia	Medida			P.V.P.	P.V.P.
	Alto	Ancho	E-Ejes		
T/A50 CR	800	500	450	—	176 €
T/B50 CR	1180	500	450	—	264 €
T/C50 CR	1600	500	450	—	353 €
T/A55 CR	800	550	500	—	183 €
T/B55 CR	1180	550	500	—	273 €
T/C55 CR	1600	550	500	—	366 €

Elba

Blanco

Cromo

Referencia	Medida			P.V.P.	P.V.P.
	Alto	Ancho	E-Ejes		
E/A50 CR	800	500	450	—	193 €
E/B50 CR	1180	500	450	—	261 €
E/C50 CR	1600	500	450	—	353 €

Bali

Blanco

Cromo

Referencia	Medida			P.V.P.	P.V.P.
	Alto	Ancho	E-Ejes		
BA/A50 CR	800	500	450	—	173 €
BA/B50 CR	1180	500	450	—	245 €

Madeira

Blanco

Cromo

Referencia	Medida			P.V.P.	P.V.P.
	Alto	Ancho	E-Ejes		
MA/A50 CR	800	500	450	—	157 €
MA/B50 CR	1180	500	450	—	222 €



Bermudas

Blanco

Cromo

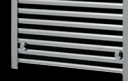

Referencia	Medidas en milímetros			P.V.P.	P.V.P.
	Alto	Ancho	E-Ejes		
BE/A45	800	450	400	77 € *	149 €
BE/A50	800	500	450	79 € *	163 €
BE/A55	800	550	500	82 € *	173 € *
BE/A60	800	600	550	89 € *	415 € *
BE/A65	800	650	600	92 €	433 €
BE/A75	800	750	700	—	513 €
BE/A100	800	1000	950	—	546 €
BE/B45	1180	450	400	98 € *	215 €
BE/B50	1180	500	450	100 € *	229 €
BE/B55	1180	550	500	105 € *	239 €
BE/B60	1180	600	550	111 € *	251 €
BE/B75	1180	750	700	207 € *	723 €
BE/B100	1180	1000	950	—	745 €
BE/C45	1500	450	400	—	712 €
BE/C50	1500	500	450	117 € *	282 € *
BE/C55	1500	550	500	—	296 € *
BE/C65	1500	650	600	—	720 €
BE/C75	1500	750	700	265 € *	—
BE/C100	1500	1000	950	—	983 €
BE/D45	1800	450	400	—	793 €
BE/D50	1800	500	450	155 €	—
BE/D55	1800	550	500	160 €	— *
BE/D60	1800	600	550	—	803 € *
BE/D100	1800	1000	950	—	1096 €

*Disponible con salidas laterales

*Con salidas laterales añadir 10 € al P.V.P.

Capri

Blanco

Cromo



Referencia	Medidas en milímetros			P.V.P.	P.V.P.
	Alto	Ancho	E-Ejes		
C/A45	800	450	400	122 €	518 €
C/A50	800	500	450	81 €	168 €
C/A55	800	550	500	101 €	541 €
C/A60	800	600	550	127 €	554 €
C/B45	1180	450	450	174 €	741 €
C/B50	1180	500	500	115 €	239 €
C/B55	1180	550	550	180 €	771 €
C/C45	1500	450	500	218 €	893 €
C/C50	1500	500	600	223 €	—
C/C55	1500	550	450	229 €	933 €
C/C60	1500	600	500	—	947 €
C/D45	1800	450	600	254 €	1063 €
C/D50	1800	500	400	260 €	1085 €
C/D55	1800	550	400	—	1094 €
C/D60	1800	600	400	—	1110 €

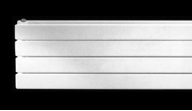

Azores

Blanco

Cromo



Referencia	Medida			P.V.P.	P.V.P.
	Alto	Ancho	Entre Ejes		
AZ/A50 BL	800	500	450	60 €	100 €
AZ/B50 BL	1180	500	450	90 €	—
AZ/C50 BL	1500	500	450	96 €	—

Vulcano

Blanco

Cromo



Referencia	Medida			P.V.P.	P.V.P.
	Alto	Ancho	Entre Ejes		
V/A50	700	500	450	48 €	114 €

Picchio Double

Color



Referencia	Medida			P.V.P.
	Alto	Ancho	Entre Ejes	
PC08D	1010	605	960	410 €
PC09D	1010	680	1160	485 €

Pispola Double

Color

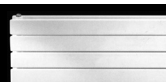

Referencia	Medida			P.V.P.
	Alto	Ancho	Entre Ejes	
PS08D	605	1010	960	410 €
PS09D	680	1010	960	485 €

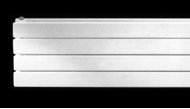

Eléctricos con termostato

Alto	
800	al precio del radiador elegido. Incrementar
1180	al precio del radiador elegido. Incrementar
1500	al precio del radiador elegido. Incrementar
1800	al precio del radiador elegido. Incrementar

CE

Blanco

Cromo

P.V.P.
106 €
120 €
140 €
145 €

P.V.P.
137 €
148 €
168 €
175 €



Eléctricos sin termostato

Alto	
800	al precio del radiador elegido. Incrementar
1180	al precio del radiador elegido. Incrementar
1500	al precio del radiador elegido. Incrementar
1800	al precio del radiador elegido. Incrementar

Blanco

Cromo

P.V.P.
98 €
110 €
130 €
135 €

P.V.P.
98 €
110 €
130 €
135 €



Radiadores mixtos

Alto	
800	al precio del radiador elegido. Incrementar
1180	al precio del radiador elegido. Incrementar
1500	al precio del radiador elegido. Incrementar
1800	al precio del radiador elegido. Incrementar

CE

Blanco

Cromo

P.V.P.
104 €
118 €
138 €
143 €

P.V.P.
135 €
146 €
160 €
173 €



Resistencias

Resistencias de 350 V
Resistencias de 650 V
Resistencias de 900 V

CE

SIN TERMOSTATO

PARA TERMOSTATO

P.V.P.
33 €
35 €
37 €

P.V.P.
42 €
44 €
45 €



Termostato



Cromo

P.V.P.
71 €

CE



Blanco

P.V.P.
48 €



Accesorios

Toalleros

Cromado

Toallero cromado recto para radiador secatoallas

Referencia	Medida Entre Ejes	P.V.P.
TR/45CR	45	18 €
TR/50CR	50	20 €



Toallero cromado curvo para radiador secatoallas

Referencia	Medida Entre Ejes	P.V.P.
T/45CR	45	15 €
T/50CR	50	16 €

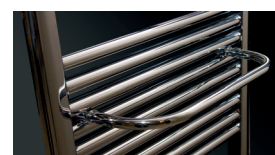

Percha

Cromado

Referencia	P.V.P.
PCC (blister de 2 unidades)	10 €



Cubre tubos cromado

Ref. CTC
Válido para tubos de Cobre Ø15; Multicapa Ø16; PEX Ø16
(Caja 2 unidades)

P.V.P.
8 €



Ref. CONEXION
Tuerca de 1/2" 100 x ø15 (Caja 2 unidades)

P.V.P.
10 €



Válvulas

Ref. VRYD

Kit válvula radiador y detentor
*Incluye tuercas y conexiones

Componentes:

Válvula Cromada 1/2" x 1/2"

Detentor Cromado 1/2" x 1/2"

Racor Conexión Tubo Cobre Ø15 (2 unidades)

Racor Conexión Tubo Multicapa/Pex Ø16 (2 unidades)

CROMO

P.V.P.

40 €



Kit válvula angular radiador termostática

Ref. VRTAYD

Kit válvula termostática y detentor angular con cabezal
*Incluye tuercas y conexiones

Componentes:

Válvula Angular Cromada 1/2" x 1/2"

Detentor Angular Cromado 1/2" x 1/2"

Cabezal Termostático

Racor Conexión Tubo Cobre ø15 (2 unidades)

Racor Conexión Tubo Multicapa/Pex Ø16 (2 unidades)

P.V.P.

70 €

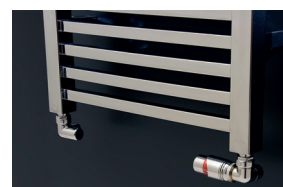

Cabezal termostático

Ref. CT

Cabezal Termostático

P.V.P.

35 €



Kit para tuberías

Racor Conexión Tubo cobre Ø15 (2 unidades)

P.V.P.

2,95 €



Racor Conexión Tubo COBRE

Racor Conexión Tubo M-C Ø16 x 2 (unidades)

P.V.P.

2,95 €



Racor Conexión Tubo MULTICAPA



Avda. del Cid, 4-6 - 46134 FOYOS (Valencia)
Teléfono: 96 149 31 61 Fax Comercial: 96 149 27 61
Fax Almacén 96 148 06 02
E-mail: comercial@r-calderon.com / www.rodriuezcalderon.com