

STRONG

LA COLECCIÓN MÁS FUERTE DE *SERGIO LUPPI*

Sergio Luppi
baño

Sergio Luppi

baño

Sergio Luppi presents his new collection; STRONG. Made in materials with strong technological innovations, it gives as a result its most resistant, strong and modern collection.

Sergio Luppi presenta su nueva colección; STRONG. Construida en materiales con fuertes innovaciones tecnológicas, da como resultado su colección más resistente, fuerte y moderna.

Sergio Luppi présente sa nouvelle collection; STRONG. Construit avec des matériaux à fortes innovations technologiques, il donne sa collection la plus résistante, la plus forte et la plus moderne.



Detail of the handle Lucky
Detalle del tirador Lucky
Détail de la poignée Lucky



STACK Pags 10 - 25



HANG Pags 26 - 41



TWO HANG Pags 42 - 49



SUPPORT Pags 50 - 65



FLOOR Pags 66 - 79



TWO FLOOR Pags 80 - 87





HAND MADE

Cuidamos cada detalle, utilizando materiales y acabados de primera calidad que alargan de forma considerable la vida útil del mobiliario.

We take care of every detail using materials and premium finishes that can lengthen furniture life.

Nous prenons soin de chaque détail en utilisant des matériaux et des finitions de première qualité qui prolongent la durée de vie du meuble.



HIGH TECH

Tecnologías y sistemas informáticos de última generación que nos permiten una rápida respuesta de gestión y entrega.

Technologies and next generation of computer systems allow us a quick management and delivery response.

Technologies et nouvelle génération de système informatique pour une gestion et une livraison rapide.

HIGH QUALITY

Trabajamos con proveedores, quienes homologan y certifican sus materiales.

Por lo que utilizamos materias primas y componentes de la máxima calidad en la fabricación de nuestros muebles de baño.

We work with suppliers, who approve and certify their materials. We use raw materials and components of the highest quality in the manufacture of our bathroom furniture.

Nous travaillons avec des partenaires qui homologuent et certifient leurs matériels car nous utilisons des matières premières et composants de haute qualité dans la fabrication de nos meubles de salle de bain.

THE FACTORY

10,000 M² de instalaciones perfectamente automatizadas y preparadas para cualquier proyecto.

10,000 M² of fully automated and prepared facilities for any project.

10,000 M² d'installations totalement automatisées et préparées pour tout projet.



ECO COMM.

Compromiso con el desarrollo sostenible con el medio ambiente y la correcta gestión ambiental en todos nuestros procesos de fabricación.

Commitment to sustainable development, the environment and the correct environmental management in all our manufacturing processes.

Engagement de développement durable, respect de l'environnement et bonne gestion environnementale dans toutes les phases de fabrication.

TECH DEPT.

Con nuestro equipo altamente cualificado, somos capaces de realizar todos los proyectos en los que trabajamos.

Producimos de principio a fin. With our highly qualified team, we are able to do all the projects in which we work.

Grâce à notre équipe hautement qualifiée, nous sommes capables de réaliser tous nos projets du début jusqu'à la touche finale.



CARACTERÍSTICAS DE FABRICACIÓN

MANUFACTURING CHARACTERISTICS / CARACTÉRISTIQUES DE FABRICATION

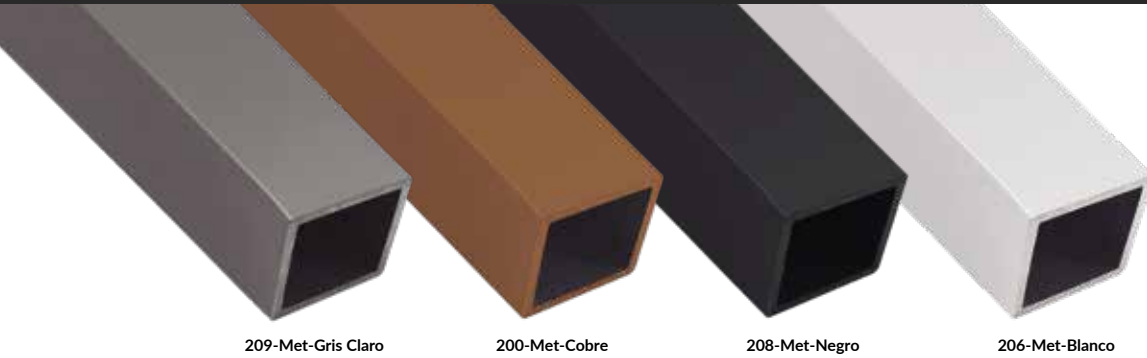

209-Met-Gris Claro

200-Met-Cobre

208-Met-Negro

206-Met-Blanco

The metal structures of Sergio Luppi, are manufactured in welded steel and painted epoxy, in white, black, copper or light gray finish.

These structures, thanks to their great variety of designs, can be used as a base for countertops integrated in different materials. And combine with different furniture designs in HPL laminate finishes.

Las estructuras metálicas de Sergio Luppi, se fabrican en acero soldado y pintado epoxy, en acabado blanco, negro, cobre o gris claro.

Estas estructuras, gracias a su gran variedad de diseños, se pueden utilizar como base de encimeras integradas en diferentes materiales. Y combinar con diferentes diseños de muebles en acabados laminados HPL.

Les structures métalliques de Sergio Luppi sont fabriquées en acier soudé et en époxy peint, en blanc, noir, cuivre ou gris clair.

Grâce à leur grande variété de conceptions, ces structures peuvent servir de base à des comptoirs intégrés dans différents matériaux. Et combiner avec différents modèles de meubles dans les finitions en stratifié HPL.



Fronts and doors / **Frentes y puertas** / Fronts et portes



Frames / **Armazones** / Cadres

Fronts and doors / **Frentes y puertas** / Fronts et portes

Manufactured in compact HPL laminate with extreme shock resistance, water-repellent and in fenix finishes with antibacterial treatment.

Fabricados en Laminado HPL compacto con una resistencia extrema a los golpes, hidrófugo y en acabados fenix con tratamiento antibacteriano.

Fabriqué en stratifié HPL compact avec une résistance extrême aux chocs, hydrofuge et fini fenix avec traitement antibactérien.

Frames / **Armazones** / Cadres

Manufactured in laminated HPL laminate on chipboard. Providing resistance to shock and with antibacterial treatment in Fenix finishes.

Fabricados en laminado aplacado HPL sobre tablero de particulas. Aportando resistencia a los golpes y con tratamiento antibacteriano en acabados Fenix.

Fabriqué en stratifié stratifié HPL sur des panneaux de particules. Fournit une résistance aux chocs et un traitement antibactérien dans les finitions Fenix.

CARACTERÍSTICAS DE LOS ACABADOS

CHARACTERISTICS OF THE FINISHES / CARACTÉRISTIQUES DES FINITIONS

HPL FENIX

It is an innovative product that combines elegant aesthetic solutions and state-of-the-art technological features.
It is produced with new generation resins.

The surface is extraordinarily matte, digital anti-fingerprint, pleasant and soft to the touch. Thanks to the use of nanotechnology, it is capable of regenerating itself from possible micro-scratches through a thermal repair process, as its name suggests.

In addition HPL Fenix is highly resistant to scratching, abrasion, rubbing and dry heat. It is very resistant to blows, acid solvents and household reagents. It has a high activity of abatement of the bacterial load that makes its surface hygienic and easy to clean. It is also waterproof and anti-mold.

Es un producto innovador que combina elegantes soluciones estéticas y prestaciones tecnológicas de vanguardia.

Se produce con resinas de nueva generación.

La superficie es extraordinariamente mate, antihuella digital, agradable y suave al tacto. Gracias al uso de la nanotecnología, es capaz de regenerarse de posibles microarañazos mediante un proceso de reparación térmica, como indica su propio nombre.

Además HPL Fenix es altamente resistente al rayado, a la abrasión, al roce y al calor seco. Resiste muy bien a los golpes, a los disolventes ácidos y a los reactivos de uso doméstico. Presenta una alta actividad de abatimiento de la carga bacteriana que hace que su superficie resulte higiénica y fácil de limpiar. También es hidrófugo y antimoho.

C'est un produit innovant qui combine des solutions esthétiques élégantes et des caractéristiques technologiques de pointe.

Il est produit avec des résines de nouvelle génération.

The surface est extraordinairement mate, digitale anti-empreintes digitales, agréable et douce au toucher. Grâce à l'utilisation de la nanotechnologie, elle est capable de se régénérer à partir de micro-rayures possibles grâce à un processus de réparation thermique, comme son nom l'indique.

HPL Fenix est également très résistant aux rayures, à l'abrasion, au frottement et à la chaleur sèche. Il est très résistant aux chocs, aux solvants acides et aux réactifs ménagers. Il a une forte activité de réduction de la charge bactérienne qui rend sa surface hygiénique et facile à nettoyer. Il est également étanche et anti-moisissure.

Fingerprint-proof
Anti huellas
Anti empreintes



Soft to the touch
Suave al tacto
Doux au toucher



Low reflectivity
Baja reflectancia
Faible réflectance



Micro scratches thermally repairable
Micro arañazos térmicamente reparables
Micro rayures réparables thermiquement



REF.	Finishes Acabado Finitions	HPL finishes Acabados HPL xxxxxxxxxxxxx		HPL FENIX finishes Acabados HPL FENIX xxxxxxxxxxxxx			
		Compact laminated Laminado compacto Stratifié compact	Laminated laminate Laminado aplacado Stratifié laminé				
620		✓	✓	✗	✗	✗	✗
621		✓	✓	✗	✗	✗	✗
622		✓	✓	✗	✗	✗	✗
630		✓	✓	✗	✗	✗	✗
631		✓	✓	✗	✗	✗	✗
610		✓	✓	✓	✓	✓	✓
611		✓	✓	✓	✓	✓	✓
612		✓	✓	✓	✓	✓	✓
613		✓	✓	✓	✓	✓	✓

ICONOGRAFÍA - CARACTERÍSTICAS DE FABRICACIÓN

ICONOGRAPHY - MANUFACTURING CHARACTERISTICS / ICONOGRAPHIE - CARACTÉRISTIQUES DE FABRICATION

Metal drawers Hettich with full extraction guides and cushioned closure.

Cajones metálicos Hettich con guías de extracción total y cierre amortiguado.

Tiroirs métalliques Hettich avec guides d'extraction complets et fermeture rembourrée.

Drawers in anthracite finish.

Cajones en acabado antracita.

Tiroirs en finition anthracite.



Hettich hinges integrated with soft close feature and 3-dimensional adjustment.

Bisagras Hettich, con cierre amortiguado y regulación en tres dimensiones.

Gonds Hettich, avec fermeture amortie et ajustements en trois dimensions.

Hinges in anthracite finish.

Bisagras en acabado antracita.

Charnières en finition anthracite.



Anti sag supports with height adjustment.

Colgadores con regulación en altura y sistema anti-descuelgue.

Crochets avec ajustements en hauteur et système anti-décrochage.



LED wall lights.

Focos con iluminación LED.

Projecteurs avec éclairage LED.



ICONOGRAFÍA ENCIMERAS

ICONOGRAPHY - COUNTERTOPS / ICONOGRAPHIE - COMPTOIRS

SOLIDUROC countertops cream white finish.

It is a material composed of mineral charges with a percentage of resin.
Whose strengths are hygienic and resistance.

Product made to measure and repairable.

Encimeras SOLIDUROC acabado blanco nata.

Es un material compuesto por cargas minerales con un porcentaje de resina.

Cuyos puntos fuertes son Higienico y y resistencia.

Producto realizado a medida y reparable.

SOLIDUROC comptoirs finition blanc crème.

C'est un matériau composé de charges minérales avec un pourcentage de résine.

Dont les forces sont hygiéniques et résistantes.

Produit fabriqué sur mesure et réparable.



RUBI SOLID SURFACE countertops matt white finish and gloss.

It is a material composed of mineral charges with a percentage of resin.
Whose strengths are their hygiene and resistance.

Encimeras SOLID SURFACE RUBI acabado blanco mate y brillo.

Es un material compuesto por cargas minerales con un porcentaje de resina.

Cuyos puntos fuertes son su higiene y resistencia.

Comptoirs RUBI SOLID SURFACE finition blanc mat et brillant.

C'est un matériau composé de charges minérales avec un pourcentage de résine.

Dont les atouts sont leur hygiène et leur résistance.



CUSTOM HPL countertops.

Manufactured in laminated HPL laminate on chipboard.

Providing resistance to the blows and with antibacterial treatment in Fenix finishes.

Encimeras CUSTOM HPL.

Fabricados en laminado aplacado HPL sobre tablero de particulas.

Aportandole resistencia a los golpes y con tratamiento antibacteriano en acabados Fenix.

Comptoirs HPL PERSONNALISÉS.

Fabriqué en stratifié HPL stratifié sur des panneaux de particules.

Assurant une résistance aux coups et un traitement antibactérien dans les finitions Fenix.

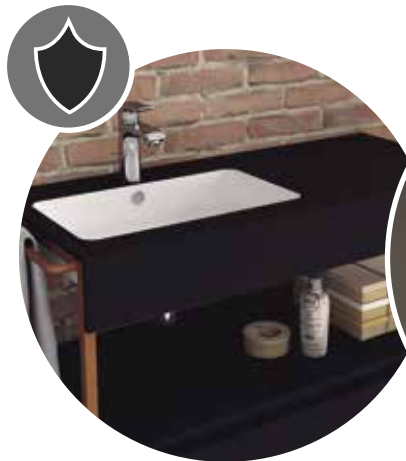



**STR
ONG**

STACK

STRONG, SÍMBOLO DE DUREZA Y ACTUALIDAD.

STRONG, HARDNESS AND CURRENT SYMBOL / STRONG, DURETÉ ET SYMBOLE ACTUEL.

Detalles cautivadores, exclusivos, refinados, con gran personalidad y carácter que irrumpen con fuerza, despertando sensaciones y emociones, una dureza y actualidad que determinan la complejidad del mobiliario.

Captivating details, exclusive, refined, with great personality and character that burst with strength, awakening sensations and emotions, hardness and topicality that determines the complexity of the furniture.

Des détails captivants, exclusifs, raffinés, avec une grande personnalité et caractère qui éclatent de force, éveillent des sensations et des émotions, dureté et actualité qui déterminent la complexité du mobilier.

Sergio Luppi
baño





STACK 01

Width / Ancho / Largeur: 120 cm.
Finish / Acabado / Fini: 621 Gris Fin



STACK 02

Width / Ancho / Largeur: 180 cm.
Finish / Acabado / Fini: 610 Nero Ingo









STACK 03

Width / Ancho / Largeur: 100 cm.
Finish / Acabado / Fini: 622 Pizarra Fin







STACK 04

Width / Ancho / Largeur: 140 cm.
Finish / Acabado / Fini: 630 Ocaso



STACK 01. Pag. 12 - 13

↔ 120 cm.

 621 Fin Grey
621 Gris Fin
 621 Gris fin

UDS.	DESCRIPCIÓN / DESCRIPTION	PT.
1	Soposte Porta Lavabos - Stack. 27,5x80x45,5 cm. Washbasin Holder - Stack. / Support de lavabo - Stack.	X7G/274
1	Encimera Solid Rubi mate con mecanizado. 81x46 cm. Matt Solid Rubi countertop with machining. / Comptoir Matt Solid Rubi avec usinage.	YER/147
1	Lavabo de apoyar Pou en mate 13x58x37 cm. Matt washbasin to support Pou. / Lavabo matt pour soutenir Pou.	L19/240
1	Bajo 1 gaveta + tapa. 27,5x120x45,5 cm. Low storage 1 drawer + top. / Sous 1 tiroir + couvercle.	XCL/571
1	Espejo bastidor Titan cromo brillo. 80x70 cm. Titan frame mirror chrome shine. / Titan cadre miroir chromé brillant.	ECO/260
1	Aplique Led africa. Ancho 45 cm. Titan frame mirror chrome shine. / Titan cadre miroir chrome brillant.	A10/69
TOTAL		SK01/1561

UDS.	DESCRIPCIÓN AUXILIAR / AUXILIAR DESCRIPTION	PT.
1	Soposte repisa auxiliar. 20x60x17 cm. Auxiliary shelf support. / Support d'étagère auxiliaire.	X7P/237
-	Toallero en soporte. Towel rack in support. / Porte-serviettes à l'appui.	50
TOTAL CON AUXILIAR		SK01/1848

STACK 02. Pag. 14 - 15

↔ 180 cm.

 610 Nero ingo
610 Nero ingo
 610 Nero ingo

UDS.	DESCRIPCIÓN / DESCRIPTION	PT.
2	Soposte Porta Lavabos - Stack. 27,5x60x45,5 cm. Washbasin Holder - Stak. / Support de lavabo - Stack.	X7G/262 X7G/262
2	Encimera Custon HPLmecanizado lavabo L05. 1,2x61x46 cm. Countertop Custom HPL machining basin L05. / Plan de travail personnalisé sur comptoir HPL L05.	YHL/159 YHL/159
2	Lavabo cerámico Flat. Ceramic washbasin Flat. / Lavabo en céramique plat.	L05/130 L05/130
1	Bajo 1 gaveta + tapa. 27,5x120x45,5 cm. Low storage 1 drawer + top. / Sous 1 tiroir + couvercle.	XCL/571
2	Espejo bastidor Titan cromo brillo. 70x60 cm. Titan frame mirror chrome shine. / Titan cadre miroir chrome brillant.	ECO/238 ECO/238
2	Aplique Led africa. Ancho 45 cm. Apply Led africa. Width 45 cm. / Appliquez Led Africa. Largeur 45 cm.	A10/069 A10/069
TOTAL		SK02/2287

STACK 03. Pag. 16 - 17



↔ 100 cm.

622 Fin Slate
622 Pizarra Fin
622 Ardoise fin

UDS.	DESCRIPCIÓN / DESCRIPTION	PT.
1	Plv. 2 cajones iguales + estantería baja 2 baldas - Stack. 55x100x45,5 cm. Plv. 2 equal drawers + low shelf 2 shelves - Stack. Plv. 2 tiroirs égaux + tablette basse 2 étagères - Stack.	XSO/859
1	Encimera Custom HPL mecanizado lavabo L03. 1,2x101x46,5 cm. Countertop Custom HPL machined washbasin L03. / Vasque à poser sur mesure en HPL L03.	YHL/263
-	Lavabo custom integrado. Integrated custom washbasin. / Lavabo sur mesure intégré.	L03/216
1	Espejo bastidor Orion cromo brillo. 80x70 cm. Orion frame mirror chrome shine. / Miroir à cadre Orion en chrome brillant.	ECO/260
1	Aplique Led Domos. Altura 28 cm. Apply Led Domes. Height 28 cm. / Appliquer des dômes led. Hauteur 28 cm.	A07/120
TOTAL		SK03/1718

STACK 04. Pag. 18 - 19



↔ 140 cm.

630 Sunset
630 Ocaso
630 Coucher de soleil

UDS.	DESCRIPCIÓN / DESCRIPTION	PT.
1	Plv. 1 Gaveta + estantería baja 1 balda - Stack. 27,5x100x45,5 cm. Plv. 1 Drawer + shelf low 1 shelf. - Stack / Plv. 1 tiroir + tablette bas 1 tablette. - Stack	XAQ/577
1	Encimera Solid Rubi en blanco mate con mecanizado Lavabo L27. 1,5x101x46 cm. Solid Rubi countertop in matt white with machining Lavabo L27. Plan de travail en Rubi massif en blanc mat avec usinage Lavabo L27.	YER/183
1	Lavabo encastrado Solid surface blanco mate. Ancho 55 cm. Built-in washbasin Solid surface matt white. 55 cm wide / Vasque à encastrer Surface solide blanc mat. 55 cm de largeur	L27/165
1	Soporte bajo 1 balda - Stack. 27,5x80x45,5 cm. Support under 1 shelf - Stak. / Support sous 1 étagère - Stak.	X7K/264
1	Tapa cm/lineal. 2x40x46 cm. Top cm / linear. / Couvrir cm / linéaire.	XTD/050
1	Espejo bastidor Titan cromo brillo. 70x70 cm. Titan frame mirror chrome shine. / Titan cadre miroir chrome brillant.	ECO/255
1	Aplique Led africa. Ancho 45 cm. Apply Led africa. Width 45 cm. / Appliquez Led Africa. Largeur 45 cm.	A10/069
1	Accesorio en Kit - Sense bath. Ancho 100 cm. Accessory in Kit - Sense bath. Width 100 cm. / Accessoire en Kit - Bain Sense. Largeur 100 cm.	TSB/129
TOTAL		SK03/1692

UDS.	DESCRIPCIÓN AUXILIAR / AUXILIAR DESCRIPTION	PT.
1	Soporte repisa auxiliar. 20x50x17 cm. Auxiliary shelf support. / Support d'étagère auxiliaire.	X7P/220
-	Incremento toallero. Towel rack increase. / Augmentation de la porta-serviette	50
TOTAL CON AUXILIAR		SK03/1962

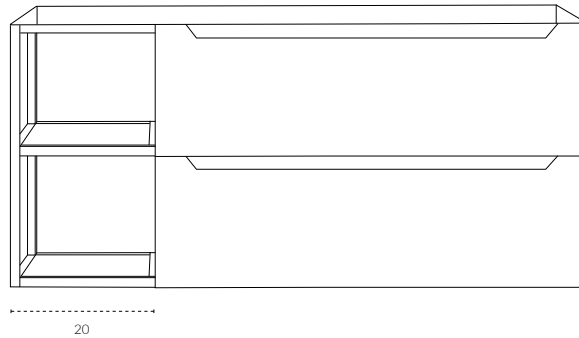

Plv. 2 equal drawers + low shelf 2 shelves Plv. 2 cajones iguales + estantería baja 2 baldas - Stack Plv. 2 tiroirs égaux + étagère basse 2 étagères	
↓ 55 ↔ 80 x ↗ 45,5	XSO/800
↓ 55 ↔ 100 x ↗ 45,5	XSO/859
↓ 55 ↔ 120 x ↗ 45,5	XSO/919
↓ 55 ↔ 140 x ↗ 45,5	XSO/978

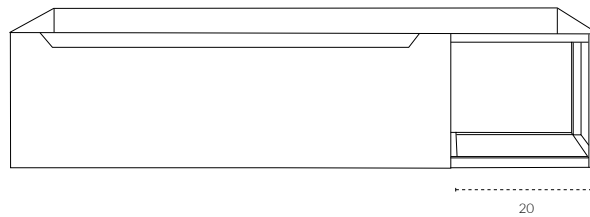

Plv. 1 drawer + low shelf 1 shelf Plv. 1 gaveta + estantería baja 1 balda - Stack Plv. 1 tiroir + tablette basse 1 tablette	
↓ 27,5 ↔ 80 x ↗ 45,5	XAQ/559
↓ 27,5 ↔ 100 x ↗ 45,5	XAQ/577
↓ 27,5 ↔ 120 x ↗ 45,5	XAQ/607
↓ 27,5 ↔ 140 x ↗ 45,5	XAQ/636

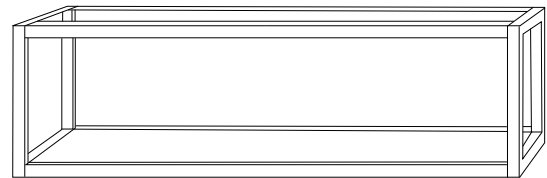
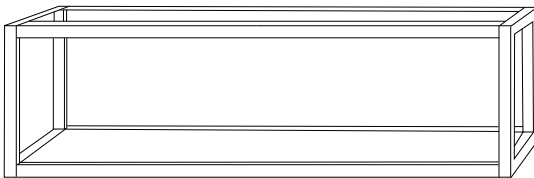

Plv. Support Soporte Plv. - Stack Support Plv.	
↓ 27,5 ↔ 60 x ↗ 45,5	X7G/262
↓ 27,5 ↔ 80 x ↗ 45,5	X7G/274
↓ 27,5 ↔ 100 x ↗ 45,5	X7G/303
↓ 27,5 ↔ 120 x ↗ 45,5	X7G/332

Support under 1 shelf Soporte bajo 1 balda - Stack Support sous 1 tablette	
↓ 27,5 ↔ 60 x ↗ 45,5	X7K/252
↓ 27,5 ↔ 80 x ↗ 45,5	X7K/264
↓ 27,5 ↔ 100 x ↗ 45,5	X7K/293
↓ 27,5 ↔ 120 x ↗ 45,5	X7K/322

There is the possibility of requesting washbasin support or support under 1 shelf.
Depending on how it is requested, the hardware system for hanging changes.
Existe la posibilidad de pedir soporte lavabo o soporte bajo 1 balda.
Dependiendo de como se pida, el sistema de herrajes para colgar, cambia.
Il est possible de demander un support de lavabo ou un support sous 1 tablette.
En fonction de la demande, le système matériel pour les modifications suspendues.

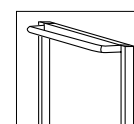

Side towel rail: + 50
Toallero lateral: + 50
Porte-serviettes latéral: + 50

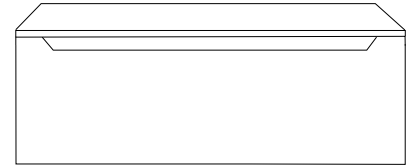
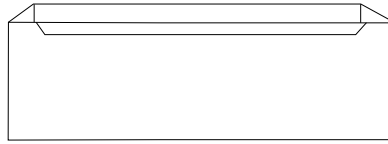
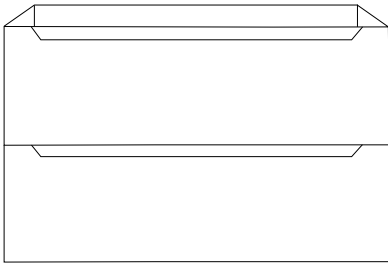

Plv. 2 equal drawers Plv. 2 gavetas iguales Plv. 2 tiroirs égaux	
↓ 55 ↔ 60 x ∅ 45,5	XSH/596
↓ 55 ↔ 80 x ∅ 45,5	XSH/634
↓ 55 ↔ 100 x ∅ 45,5	XSH/672

Plv. 1 drawer Plv. 1 gaveta Plv. 1 tiroir	
↓ 27,5 ↔ 60 x ∅ 45,5	XAI/420
↓ 27,5 ↔ 80 x ∅ 45,5	XAI/453
↓ 27,5 ↔ 100 x ∅ 45,5	XAI/486
↓ 27,5 ↔ 120 x ∅ 45,5	XAI/519

Low storage 1 drawer + top Bajo 1 gaveta + tapa Sous 1 tiroir + couvercle	
↓ 27,5 ↔ 60 x ∅ 45,5	XCL/459
↓ 27,5 ↔ 80 x ∅ 45,5	XCL/496
↓ 27,5 ↔ 100 x ∅ 45,5	XCL/534
↓ 27,5 ↔ 120 x ∅ 45,5	XCL/571

ESTANTERÍAS
SHELVES / ÉTAGÈRES

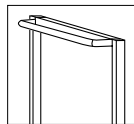
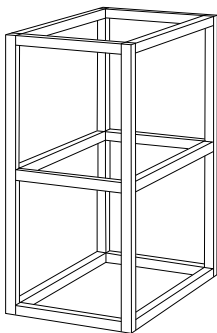

Side towel rail: + 50
Toallero lateral: + 50
Porte-serviettes latéral: + 50

Low shelving 2 shelves Estanteria baja 2 baldas - Stack Rayonnage bas 2 étagères	
↓ 55 ↔ 20 x ∅ 45,5	X7Q/343
↓ 55 ↔ 30 x ∅ 45,5	X7Q/358
↓ 55 ↔ 40 x ∅ 45,5	X7Q/381

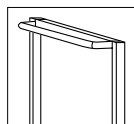
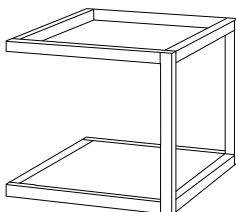

Side towel rail: + 50
Toallero lateral: + 50
Porte-serviettes latéral: + 50

Low shelving 1 shelf Estanteria baja 1 balda - Stak Rayonnage bas 1 étagère	
↓ 27,5 ↔ 20 x ∅ 45,5	X7R/194
↓ 27,5 ↔ 30 x ∅ 45,5	X7R/228
↓ 27,5 ↔ 40 x ∅ 45,5	X7R/244

AUXILIARES / AUXILIARIES

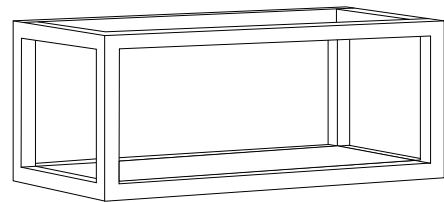

Auxiliary shelf support Soporte repisa auxiliar Support d'étagère auxiliaire	
↓ 20 ↔ 30 x ∅ 17	X7P/200
↓ 20 ↔ 40 x ∅ 17	X7P/210
↓ 20 ↔ 50 x ∅ 17	X7P/220
↓ 20 ↔ 60 x ∅ 17	X7P/237

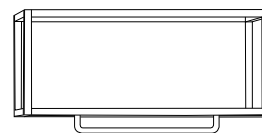

Towel rack: + 50
Toallero: + 50
Porte-serviettes: + 50
Minimum towel rack measure: 420 mm
Medida mínima toallero: 420 mm
Mesure de porte-serviette minimale: 420 mm

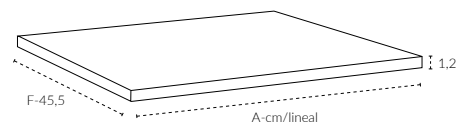

Top cm / linear Tapa cm / lineal Couverture cm / linéaire	
XTD/1.25	

Compositions / **Composiciones** / Compositions



Structure finishes / **Acabados estructura** / Finitions structure



Fenix NMT finishes / **Acabados mueble Fenix NMT** / Fenix NMT finitions



620 Blanco fin / White fin / Blanc fin



621 Gris fin / Fin grey / Gris fin



622 Pizarra fin / Fin slate / Ardoise fin



630 Ocaso / Sunset / Coucher de soleil



631 Topacio / Topaz / Topaze



610 Nero ingo



611 Blanco alaska / Alaska white / Alaska blanc

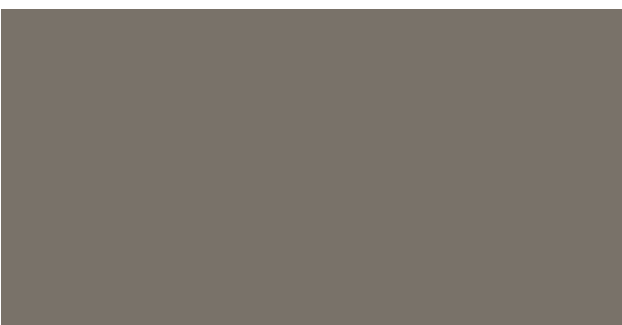

612 Grigio Ionora



613 Grigio bromo



**STR
ONG**

HANG

MOBILIARIO,
CREADO PARA
IMPRESIONAR Y
PERDURAR.

FURNITURE CREATED TO IMPRESS AND ENDURE / MEUBLES CRÉÉS POUR IMPRESSIONNER ET SUPPORTER.

Soluciones contemporáneas persiguiendo el ideal de libertad de los espacios, definiendo en sí mismo un estilo de vida, perfecta simbiosis de materiales nobles, texturas, matices, colores, ...

Contemporary solutions chasing the ideal of freedom of space, defining itself a lifestyle perfect symbiosis of noble materials, textures, shades, colors, ...

Des solutions contemporaines poursuivant l'idéal de liberté des espaces, définissant en soi un mode de vie, symbiose parfaite des matériaux nobles, des textures, des nuances, des couleurs, ...

Sergio Luppi
baño



HANG 01

Width / Ancho / Largeur: 80 cm.
Finish / Acabado / Fini: 612 Grigio Lonora





HANG 02

Width / Ancho / Largeur: 80 cm.
Finish / Acabado / Fini: 630 Ocaso





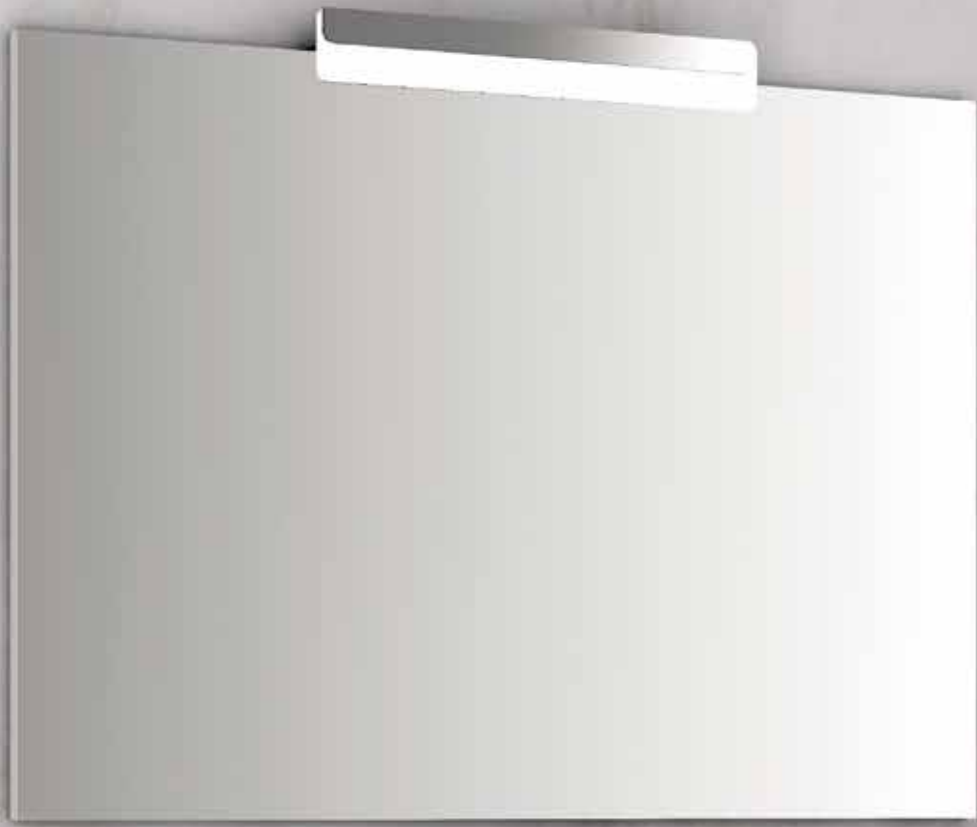



HANG 03

Width / Ancho / Largeur: 100 cm.
Finish / Acabado / Fini: 620 Blanco Fin



HANG 04

Width / Ancho / Largeur: 120 cm.
Finish / Acabado / Fini: 621 Gris Fin





HANG 01. Pag. 28 - 29

↔ 80 cm.

 612 Griogio Ionora
612 Grigio Ionora
 612 Griogio Ionora

UDS.	DESCRIPCIÓN / DESCRIPTION	PT.
1	Plv. 1 gaveta + soporte balda C - Hang. 55x80x45,5 cm. Plv. 1 drawer + shelf shelf C - Hang. / Plv. 1 tiroir + tablette C - Hang.	XAM/648
1	Lavabo Solid de apoyo Kiara - Blanco mate. 12x81x46 cm. Washbasin Solid support Kiara - Matt white. / Lavabo support Solid Kiara - Blanc mat.	LM14/274
1	Espejo Thor. Bastidor estructura metálica. 80x80 cm. Mirror Thor. Metal structure frame. / Miroir Thor. Structure en métal	EEC/187
1	Aplique Led Africa. Ancho 60 cm. Apply Led Africa. Width 60 cm. / Appliquez Led Africa. Largeur 60 cm.	A10/112
1	Accesorio en Kit - Sense bath. Ancho 100 cm. Accessory in Kit - Sense bath. Width 100 cm. / Accessoire en Kit - Bain Sense. Largeur 100 cm.	TSB/129
TOTAL		HG01/1350

HANG 02. Pag. 30 - 31

↔ 80 cm.

 630 Sunset
630 Ocaso
 630 Coucher de soleil

UDS.	DESCRIPCIÓN / DESCRIPTION	PT.
1	Plv. 1 gaveta + soporte balda C - Hang. 55x80x46,5 cm. Plv. 1 drawer + shelf shelf C - Hang. / Plv. 1 tiroir + tablette C - Hang.	XAM/648
1	Encimera Custom HPL, Faldon, mecanizado L03. 12x81x46 cm. Countertop Custom HPL, Faldon, machining L03. / Comptoir sur mesure HPL, Faldon, usinage L03.	YHL/332
-	Lavabo Custom integrado. Integrated Custom washbasin. / Lavabo intégré sur mesure.	L03/216
1	Espejo Thor. Bastidor estructura metálica. 80x80 cm. Mirror Thor. Metal structure frame. / Miroir Thor. Structure en métal	EEC/187
1	Aplique Led Africa. Ancho 60 cm. Apply Led Africa. Width 60 cm. / Appliquez Led Africa. Largeur 60 cm.	A10/112
1	Accesorio en Kit - Sense bath. Ancho 100 cm. Accessory in Kit - Sense bath. Width 100 cm. / Accessoire en Kit - Bain Sense. Largeur 100 cm.	TSB/129
TOTAL		HG02/1624

HANG 03. Pag. 32 - 33



↔ 100 cm.

620 Fin White
620 Blanco Fin
620 Blanc fin

UDS.	DESCRIPCIÓN / DESCRIPTION	PT.
1	Plv. 1 gaveta + soporte balda C - Hang. 55x100 x45,5 cm. Plv. 1 drawer + shelf shelf C - Hang. / Plv. 1 tiroir + tablette C - Hang.	XAM/700
1	Encimera Custom HPL, mecanizado lavabo L45. 1,2x101x46 cm. Custom HPL countertop, L45 washbasin machining. / Comptoir HPL personnalisé, usinage L45.	YHL/263
1	Lavabo cerámico de apoyo Fino. Ceramic support sink Fine. / Support en céramique évier Fine.	L45/173
1	Espejo bastidor Titan cromo brillo. 70x100 cm. Titan frame mirror chrome shine. / Titan cadre miroir chrome brillant.	ECO/290
1	Aplique Led Karin. Ancho 50 cm. Apply Led Karin. Width 50 cm. / Appliquez Led Karin. Largeur 50 cm.	A18/127
TOTAL		HG03/1553

HANG 04. Pag. 34 - 35



↔ 120 cm.

621 Fin Grey
621 Gris Fin
621 Gris fin

UDS.	DESCRIPCIÓN / DESCRIPTION	PT.
1	Plv. 2 gavetas simétricas + soporte balda C - Hang. 55x120x45,5 cm. Plv. 2 symmetrical drawers + shelf support C - Hang. Plv. 2 tiroirs symétriques + support d'étagère C - Hang.	XAH/912
1	Lavabo Solid Kiara con 2 pozas - Blanco mate. 12x120,5x46 cm. Solid washbasin Kiara with 2 pools - Matt white. / Lavabo support Solid Kiara avec 2 piscines - blanc mat.	LM15/370
1	Espejo bastidor Titan cromo brillo. 80x120 cm. Titan frame mirror chrome shine. / Titan cadre miroir chrome brillant.	ECO/356
2	Aplique Led Africa. Ancho 45 cm. Apply Led Africa. Width 45 cm. / Appliquez Led Africa. Largeur 45 cm.	A10/69 A10/69
TOTAL		HG04/1776

UDS.	DESCRIPCIÓN AUXILIAR / AUXILIAR DESCRIPTION	PT.
1	Alto 1 puerta + soporte repisa auxiliar. 80x30x20 cm. High 1 door + auxiliary shelf support. / Support haut 1 porte + tablette auxiliaire.	XBM/363
TOTAL CON AUXILIAR		HG04/2139

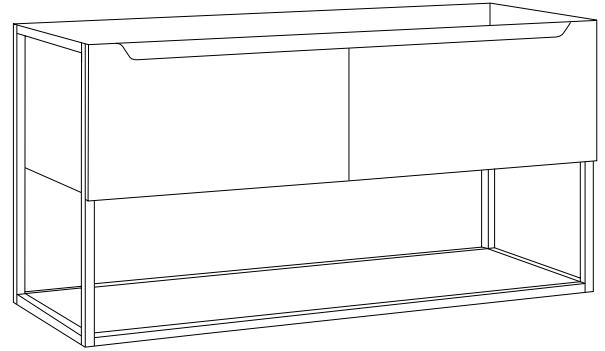
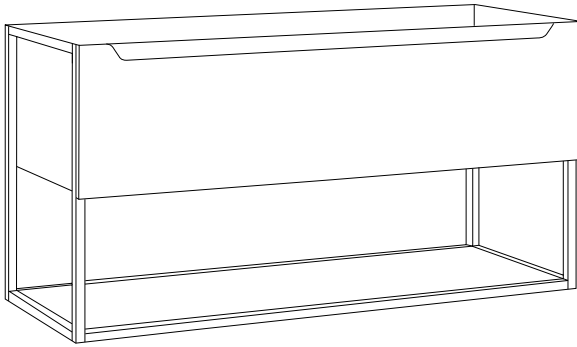

Plv. 1 drawer + shelf support C Plv. 1 gaveta + soporte balda C - Hang Plv. 1 tiroir + étagère C	
↓ 55 ↔ 60 x ↗ 45,5	XAM/605
↓ 55 ↔ 80 x ↗ 45,5	XAM/648
↓ 55 ↔ 100 x ↗ 45,5	XAM/700
↓ 55 ↔ 120 x ↗ 45,5	XAM/752

Plv 2 symmetrical drawers + shelf support C Plv 2 gavetas simétricas + soporte balda C - Hang Plv 2 tiroirs symétriques + support d'étagère C	
↓ 55 ↔ 100 x ↗ 45,5	XAH/853
↓ 55 ↔ 120 x ↗ 45,5	XAH/912
↓ 55 ↔ 140 x ↗ 45,5	XAH/971

Centered pond increment: + 90
Incremento poza centrada: + 90
 Incrément de bassin centré: + 90

AUXILIARES / AUXILIARIES

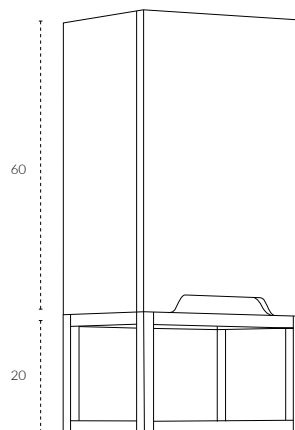

High 1 right door + auxiliary shelf support Alto 1 puerta derecha + soporte repisa auxiliar High 1 porte droite + support auxiliaire	
↓ 80 ↔ 30 x ↗ 20	XBM/363
↓ 80 ↔ 40 x ↗ 20	XBM/376
↓ 80 ↔ 50 x ↗ 20	XBM/389

SOPORTE BALDA 1

SHELF SUPPORT 1 / ÉTAGÈRE 1

HANG

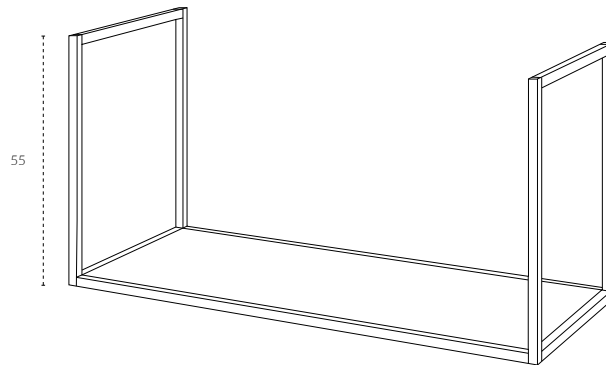

Shelf support C Soporte balda C - Hang Étagère C	
↓ 55 ↔ 60 x ↗ 45,5	X7B/260
↓ 55 ↔ 80 x ↗ 45,5	X7B/268
↓ 55 ↔ 100 x ↗ 45,5	X7B/281
↓ 55 ↔ 120 x ↗ 45,5	X7B/301
↓ 55 ↔ 140 x ↗ 45,5	X7B/321

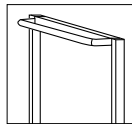

Side towel rail: + 50
Toallero lateral: + 50
 Porte-serviettes latéral: + 50

MUEBLES

FURNITURE / MEUBLES

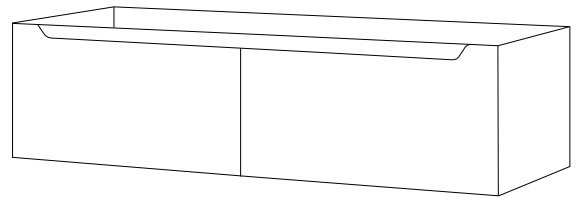
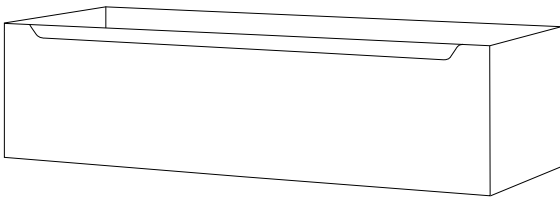

Plv. 1 drawer Plv. 1 gaveta Plv. 1 tiroir	
↓ 27,5 ↔ 60 x ↗ 45,5	XAI/420
↓ 27,5 ↔ 80 x ↗ 45,5	XAI/453
↓ 27,5 ↔ 100 x ↗ 45,5	XAI/486
↓ 27,5 ↔ 120 x ↗ 45,5	XAI/519

Plv. 2 symmetrical drawers Plv. 2 gavetas simétricas Plv. 2 tiroirs symétriques	
↓ 27,5 ↔ 100 x ↗ 45,5	XAV/710
↓ 27,5 ↔ 120 x ↗ 45,5	XAV/755
↓ 27,5 ↔ 140 x ↗ 45,5	XAV/801

Centered pond increment: + 90
Incremento poza centrada: + 90
 Incrément de bassin centré: + 90

Compositions / **Composiciones** / Compositions



Structure finishes / **Acabados estructura** / Finitions structure



Fenix NMT finishes / **Acabados mueble Fenix NMT** / Fenix NMT finitions



620 Blanco fin / White fin / Blanc fin



621 Gris fin / Fin grey / Gris fin



622 Pizarra fin / Fin slate / Ardoise fin



630 Ocaso / Sunset / Coucher de soleil



631 Topacio / Topaz / Topaze



610 Nero ingo



611 Blanco alaska / Alaska white / Alaska blanc

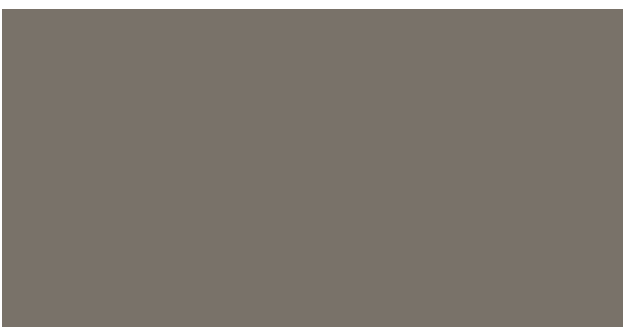

612 Grigio Ionora



613 Grigio bromo



**STR
ONG**

TWO HANG

EQUILIBRIO
PERFECTO
ENTRE ROBUSTEZ Y
CALIDAD.

PERFECT BALANCE BETWEEN ROBUSTNESS AND QUALITY /
ÉQUILIBRE PARFAIT ENTRE ROBUSTESSE ET QUALITÉ.

Conectando con las emociones, propuestas
acordes con las nuevas tendencias
decorativas, inspiradas para proporcionar
sensaciones únicas, bienestar, satisfacción,
en definitiva, calidad de vida...

Connecting with emotions, that propose new
decorative trends inspired to provide unique
sensations being, satisfaction, ultimately,
quality of life ...

*Se connecter avec des émotions, des
propositions selon les nouvelles tendances
décoratives, inspirées pour fournir des
sensations uniques, le bien-être, la
satisfaction, en bref, la qualité de vie ...*

Sergio Luppi
baño





TWO HANG

Width / Ancho / Largeur: 120 cm.
Finish / Acabado / Fini: 612 Grigio Lonora



Detail of the handle / opening Lucky
Detalle del tirador/apertura Lucky
Détail de la poignée / ouverture Lucky



↔ 120 cm.

612 Grigio Ionora
612 Grigio Ionora
 612 Grigio Ionora

UDS.	DESCRIPCIÓN / DESCRIPTION	PT.
1	Plv. 1 gaveta + 1 ptan dcha + soporte balda I/D - Two Hang. 55x120x45,5 cm. Plv. 1 drawer + 1 ptan right + shelf support I/D - Two Hang. Plv. 1 tiroir + 1 tiroir à droite + support d'étagère I/D - Two Hang.	XB3/868
1	Encimera Auto lavabo Solid Kora con poza izquierda - Blanco mate. 1,5x121x46,5 cm. Countertop washbasin Solid Kora with left side - Matt white. / Vasque à poser Solid Kora à gauche - Blanc mat.	YS1/321
1	Espejo Thor. bastidor estructura metálica. 80x80 cm. Mirror Thor. metal structure frame. / Miroir Thor. structure en métal	EEC/187
1	Aplique Led Karin. Ancho 30 cm. Led light Karin. Width 30 cm. / Appliquez Led Karin. Largeur 30 cm.	A18/112
1	Accesorio en Kit - Sense bath. Ancho 100 cm. Accessory in Kit - Sense bath. Width 100 cm. / Accessoire en Kit - Bain Sense. Largeur 100 cm.	TSB/129
TOTAL		THG01/1617

UDS.	DESCRIPCIÓN AUXILIAR / AUXILIAR DESCRIPTION	PT.
2	Soposte repisa auxiliar. 20x50x17 cm. Auxiliary shelf support. / Support d'étagère auxiliaire.	X7P/221 X7P/221
TOTAL CON AUXILIAR		THG01/2059

PACKS: MUEBLE + SOPORTE BALDA 2
 PACKS: FURNITURE + SHELF SUPPORT 2 / PACKS: MEUBLES + SUPPORT ÉTAGÈRE 2

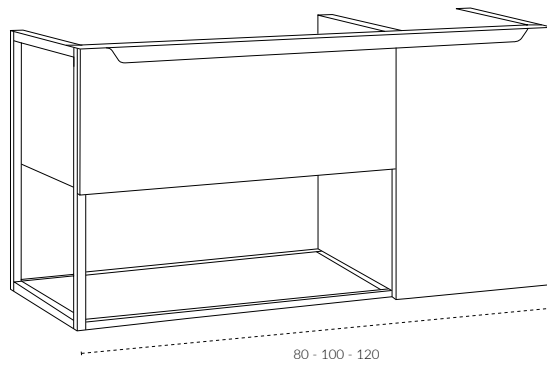

Plv. 1 drawer + 1 ptan right + shelf support I/D Plv. 1 gaveta + 1 pta. dcha. + soporte balda I/D - Two Hang Plv. 1 tiroir + 1 tiroir à droite + support d'étagère I/D	
↓ 55 ↔ 80 x ∅ 45,5	XB3/754
↓ 55 ↔ 100 x ∅ 45,5	XB3/811
↓ 55 ↔ 120 x ∅ 45,5	XB3/868

Total width Ancho total Largeur totale	Shelf support width 2 Ancho soporte balda 2 Largeur de support d'étagère 2
80	55
100	65
120	75

SOPORTE BALDA 2
 SHELF SUPPORT 2 / SUPPORT ÉTAGÈRE 2

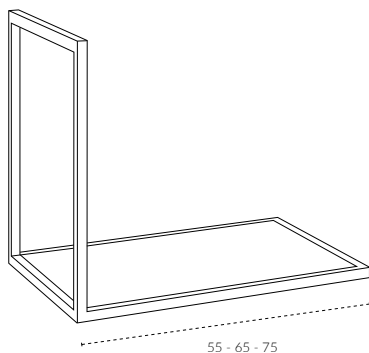

Support shelf I/D Soporte balda I/D - Two Hang Etagère de support I/D	
↓ 55 ↔ 55 x ∅ 45,5	X7F/211
↓ 55 ↔ 65 x ∅ 45,5	X7F/217
↓ 55 ↔ 75 x ∅ 45,5	X7F/228

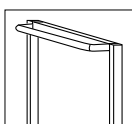

Side towel rail: + 50
Toallero lateral: + 50
 Porte-serviettes latéral: + 50
 Minimum towel rack measure: 420 mm
Medida mínima toallero: 420 mm
 Mesure de porte-serviette minimale: 420 mm

AUXILIARES / AUXILIARIES

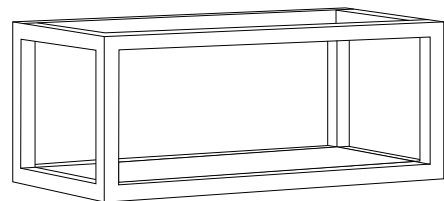

Auxiliary shelf support Soporte repisa auxiliar Support d'étagère auxiliaire	
↓ 20 ↔ 30 x ∅ 17	X7P/200
↓ 20 ↔ 40 x ∅ 17	X7P/210
↓ 20 ↔ 50 x ∅ 17	X7P/221
↓ 20 ↔ 60 x ∅ 17	X7P/237



Towel rack: + 50
Toallero: + 50
 Porte-serviettes: + 50
 Minimum towel rack measure: 420 mm
Medida mínima toallero: 420 mm
 Mesure de porte-serviette minimale: 420 mm

Compositions / **Composiciones** / Compositions



Structure finishes / **Acabados estructura** / Finitions structure

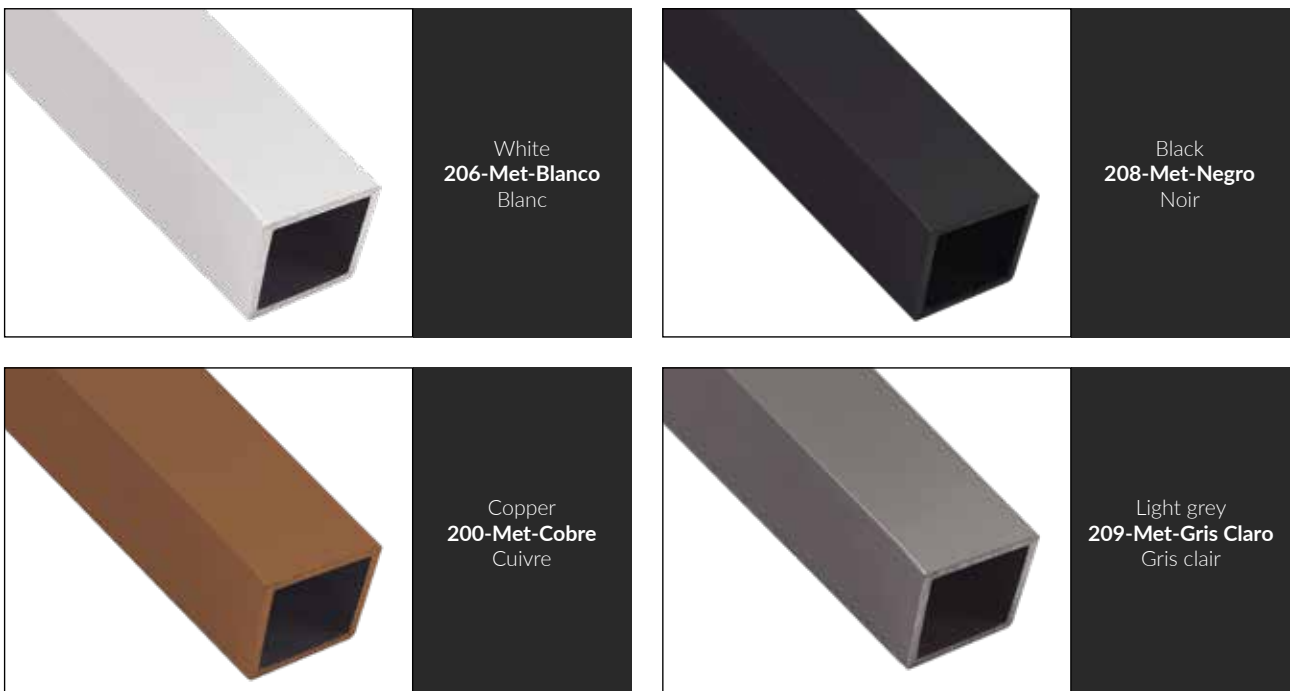

Fenix NMT finishes / **Acabados mueble Fenix NMT** / Fenix NMT finitions



620 Blanco fin / White fin / Blanc fin



621 Gris fin / Fin grey / Gris fin



622 Pizarra fin / Fin slate / Ardoise fin



630 Ocaso / Sunset / Coucher de soleil



631 Topacio / Topaz / Topaze



610 Nero ingo



611 Blanco alaska / Alaska white / Alaska blanc

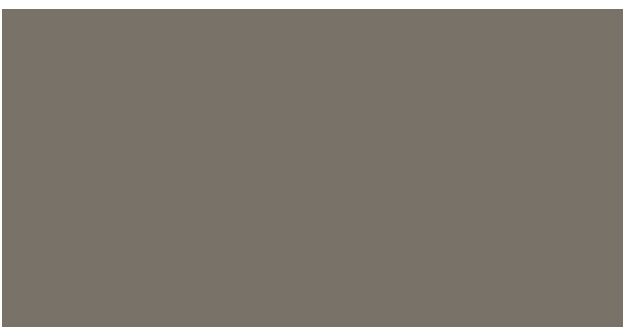

612 Grigio Ionora



613 Grigio bromo



**STR
ONG**

SUPPORT

SINGULAR MEZCLA ENTRE ESTILO Y VANGUARDIA.

SINGULAR MIX BETWEEN STYLE AND AVANT-GARDE / MÉLANGE SINGULIER ENTRE STYLE ET AVANT-GARDE.

Espacios acogedores que se integran en cualquier entorno. Funcionalidad y estética cogidas de la mano en esta colección, singular mezcla de estilo y vanguardia.

Welcoming spaces that are integrated into any environment. Functionality and aesthetics hand in hand in this collection, a unique blend of style and avant-garde.

Des espaces accueillants qui sont intégrés dans n'importe quel environnement. Fonctionnalité et esthétique main dans la main dans cette collection, un mélange unique de style et d'avant-garde.

Sergio Luppi
baño





SUPPORT 01

Width / Ancho / Largeur: 120 cm.
Finish / Acabado / Fini: 610 Nero Ingo







SUPPORT 02

Width / Ancho / Largeur: 100 cm.
Finish / Acabado / Fini: 631 Topacio







SUPPORT 03

Width / Ancho / Largeur: 80 cm.
Finish / Acabado / Fini: 622 Pizarra Fin







SUPPORT 04

Width / Ancho / Largeur: 100 cm.
Finish / Acabado / Fini: 630 Ocaso



SUPPORT 01. Pag. 52 - 53



↔ 120 cm.

610 Nero ingo
610 Nero ingo
 610 Nero ingo

UDS.	DESCRIPCIÓN / DESCRIPTION	PT.
1	Estructura Plv. + bajo 1 gaveta - Support. 87x120x45,5 cm. Plv. structure. + under 1 drawer - Support. / Structure Plv. + sous 1 tiroir - Support.	XCW/739
1	Incremento Toallero lateral. Lateral towel rail increase. / Le porte-serviettes latéral augmente.	50
1	Encimera Custom HPL, Faldon, mecanizado L03. 12x121x47 cm. Countertop Custom HPL, Faldon, machining L03. / Comptoir sur mesure HPL, Faldon, usinage L03.	YHL/496
-	Lavabo integrado custom. Built-in washbasin custom. / Lavabo intégré sur mesure.	L03/216
1	Espejo Bastidor Titan cromo brillo. 70x100 cm. Titan chrome mirror frame. / Cadre de miroir titan chromé.	ECO/290
-	Retroiluminado luz superior. Backlit top light. / Lumière supérieure rétroéclairée.	105
TOTAL		SP01/1896

UDS.	DESCRIPCIÓN AUXILIAR / AUXILIAR DESCRIPTION	PT.
1	Semi columna 1 puerta + soporte repisa auxiliar + 1 puerta. 140x30x20 cm. Semi column 1 door + auxiliary shelf support + 1 door. / Semi colonne 1 porte + support de tablette auxiliaire + 1 porte.	XSU/512
TOTAL CON AUXILIAR		SP01/2408

SUPPORT 02. Pag. 54 - 55



↔ 100 cm.

631 Topaz
631 Topacio
 631 Topaze

UDS.	DESCRIPCIÓN / DESCRIPTION	PT.
1	Estructura Plv. + balda - Support. 87x100x45,5 cm. Plv. structure. + shelf - Support. / Structure Plv. + étagère - Support.	X7M/400
1	Encimera Custom HPL, Faldon, mecanizado L03. 12x101x47 cm. Countertop Custom HPL, Faldon, machining L03. / Comptoir sur mesure HPL, Faldon, usinage L03.	YHL/414
-	Lavabo integrado custom. Built-in washbasin custom. / Lavabo intégré sur mesure.	L03/216
1	Espejo Bastidor Titan cromo brillo. 70x100 cm. Titan chrome mirror frame. / Cadre de miroir titan chromé.	ECO/290
-	Retroiluminado luz superior. Backlit top light. / Lumière supérieure rétroéclairée.	105
TOTAL		SP02/1425

UDS.	DESCRIPCIÓN AUXILIAR / AUXILIAR DESCRIPTION	PT.
1	Semi columna 1 puerta + soporte repisa auxiliar + 1 puerta. 140x30x20 cm. Semi column 1 door + auxiliary shelf support + 1 door. / Semi colonne 1 porte + support de tablette auxiliaire + 1 porte.	XSU/512
TOTAL CON AUXILIAR		SP02/1937

SUPPORT 03. Pag. 56 - 57



↔ 80 cm.

622 Fin Slate
622 Pizarra Fin
622 Ardoise fin

UDS.	DESCRIPCIÓN / DESCRIPTION	PT.
1	Estructura Plv. + bajo 1 gaveta - Support. 87x80x45,5 cm. Plv. structure. + under 1 drawer - Support. / Structure Plv. + sous 1 tiroir - Support.	XCW/638
1	Encimera Custom HPL, Faldon mecanizado L03. 12x81x47 cm. Countertop Custom HPL, machined Faldon L03. / Comptoir sur mesure HPL, Faldon L03 usiné.	YHL/333
-	Lavabo integrado custom. Built-in washbasin custom. / Lavabo intégré sur mesure.	L03/216
1	Espejo Bastidor Titan Cromo brillo. 70x80 cm. Titan Frame Mirror Bright Chrome. / Titan Frame Mirror Bright Chrome.	ECO/255
-	Retroiluminado luz superior. Backlit top light. / Lumière supérieure rétroéclairée.	105
1	Accesorio en Kit - Sense bath. Ancho 80 cm. Accessory in Kit - Sense bath. Width 80 cm. / Accessoire en Kit - Bain Sense. Largeur 80 cm.	TSB/124
TOTAL		SP03/1671

UDS.	DESCRIPCIÓN AUXILIAR / AUXILIAR DESCRIPTION	PT.
1	Semi columna 1 puerta + soporte repisa auxiliar + 1 puerta. 140x30x20 cm. Semi column 1 door + auxiliary shelf support + 1 door. / Semi colonne 1 porte + support de tablette auxiliaire + 1 porte.	XSU/512
TOTAL CON AUXILIAR		SP03/2183

SUPPORT 04. Pag. 58 - 59



↔ 100 cm.

630 Sunset
630 Ocaso
630 Coucher de soleil

UDS.	DESCRIPCIÓN / DESCRIPTION	PT.
1	Estructura Plv. + balda + bajo 1 gaveta - Support. 87x100x45,5 cm. Plv. structure. + shelf + 1 drawer - Support. / Structure Plv. + étagère + 1 tiroir - Support.	XCR/723
1	Encimera Custom HPL, faldon, mecanizado L03. 12x101x47 cm. Countertop Custom HPL, faldon, machining L03. / Comptoir sur mesure HPL, faldon, usinage L03.	YHL/414
-	Lavabo integrado custom. Built-in washbasin custom. / Lavabo intégré sur mesure.	L03/216
1	Espejo Bastidor Titan Cromo brillo. 70x100 cm. Titan Frame Mirror Bright Chrome. / Titan Frame Mirror Bright Chrome.	ECO/290
-	Retroiluminado luz superior. Backlit top light. / Lumière supérieure rétroéclairée.	105
TOTAL		SP04/1748

UDS.	DESCRIPCIÓN AUXILIAR / AUXILIAR DESCRIPTION	PT.
1	Semi columna 1 puerta + soporte repisa auxiliar + 1 puerta. 140x30x20 cm. Semi column 1 door + auxiliary shelf support + 1 door. / Semi colonne 1 porte + support de tablette auxiliaire + 1 porte.	XSU/512
TOTAL CON AUXILIAR		SP04/2260

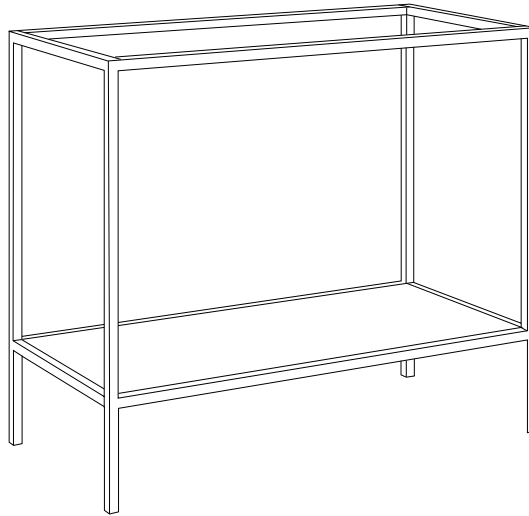

Plv. structure + shelf Estructura Plv. + balda - Support Structure Plv. + étagère	
↓ 87 ↔ 80 x ↗ 45,5	X7M/373
↓ 87 ↔ 100 x ↗ 45,5	X7M/400
↓ 87 ↔ 120 x ↗ 45,5	X7M/433

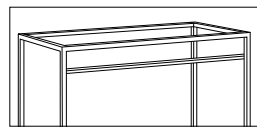

Front towel rack: + 40
Toallero frontal: + 40
Porte-serviettes avant: + 40

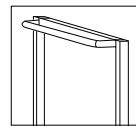

Side towel rack (Minimum measurement 420 mm): + 50
Toallero lateral (Medida mínima 420 mm): + 50
Porte-serviettes latéral (Mesure minimum 420 mm): + 50

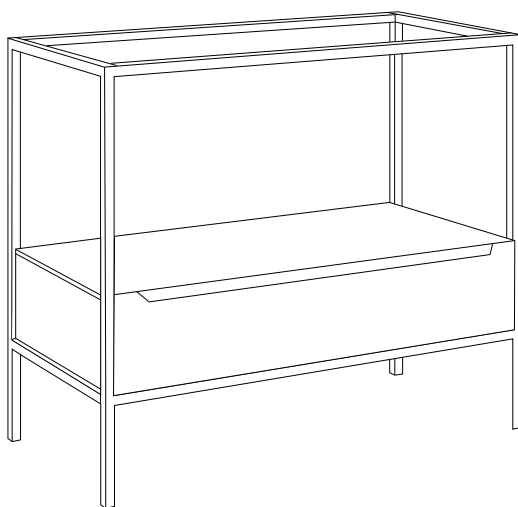

Plv. structure. + under 1 drawer Estructura Plv. + bajo 1 gaveta - Support Structure Plv. + sous 1 tiroir	
↓ 87 ↔ 80 x ↗ 45,5	XCW/638
↓ 87 ↔ 100 x ↗ 45,5	XCW/688
↓ 87 ↔ 120 x ↗ 45,5	XCW/739

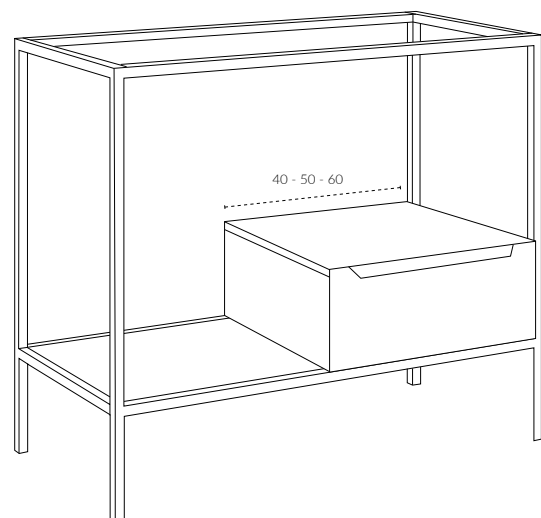

Plv. structure. + shelf + 1 drawer Estructura Plv. + balda + bajo 1 gaveta - Support Structure Plv. + étagère + 1 tiroir	
↓ 87 ↔ 80 x ↗ 45,5	XC1/668
↓ 87 ↔ 100 x ↗ 45,5	XC1/723
↓ 87 ↔ 120 x ↗ 45,5	XC1/779

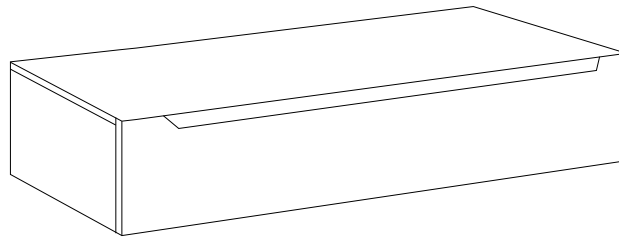

Low storage 1 drawer + top Bajo 1 gaveta + tapa Sous 1 tiroir + couvercle	
↓ 20 ↔ 40 x ↗ 45,5	XCL/422
↓ 20 ↔ 60 x ↗ 45,5	XCL/459
↓ 20 ↔ 80 x ↗ 45,5	XCL/496
↓ 20 ↔ 100 x ↗ 45,5	XCL/534
↓ 20 ↔ 120 x ↗ 45,5	XCL/571

AUXILIARES / AUXILIARIES

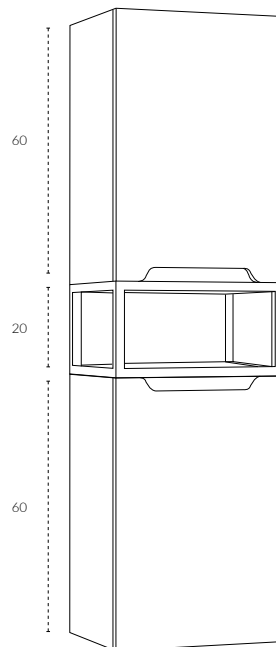

Semi column 1 door + auxiliary shelf support + 1 door Semi columna 1 puerta + soporte repisa auxiliar + 1 puerta Semi colonne 1 porte + support de tablette auxiliaire + 1 porte	
↓ 140 ↔ 30 x ↗ 20	XSU/512
↓ 140 ↔ 40 x ↗ 20	XSU/529
↓ 140 ↔ 50 x ↗ 20	XSU/545

Compositions / **Composiciones** / Compositions



Structure finishes / **Acabados estructura** / Finitions structure



Fenix NMT finishes / **Acabados mueble Fenix NMT** / Fenix NMT finitions



620 Blanco fin / White fin / Blanc fin



621 Gris fin / Fin grey / Gris fin



622 Pizarra fin / Fin slate / Ardoise fin



630 Ocaso / Sunset / Coucher de soleil



631 Topacio / Topaz / Topaze



610 Nero ingo



611 Blanco alaska / Alaska white / Alaska blanc

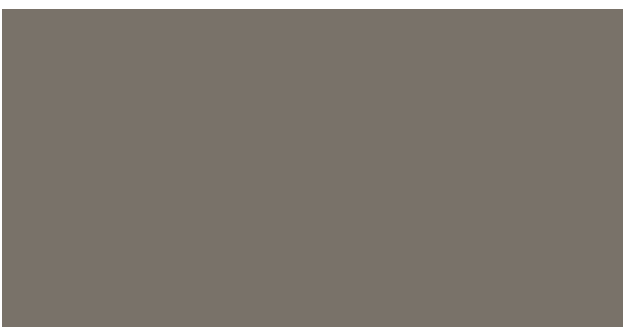

612 Grigio Ionora



613 Grigio bromo





**STR
ONG**
FLOOR

AUTÉNTICA
DEDICACIÓN
POR LOS DETALLES
EN EL BAÑO.

AUTHENTIC DEDICATION TO DETAIL IN THE BATHROOM /
UN DÉVOUEMENT AUTHENTIQUE AU DÉTAIL DANS LA SALLE DE BAIN.

Líneas de diseño urbanas, inconfundibles y coherentes con una forma de pensar y entender el mobiliario de baño. Nada es casual en la colección STRONG, hasta el más mínimo detalle está analizado y pensado para resultar perfecto.

Urban design lines, unmistakable and coherent with a way of thinking and understanding bathroom furniture. Nothing is casual in the STRONG collection, even the smallest detail is analyzed and thought to be perfect.

Lignes de design urbain, indéniables et cohérentes avec une façon de penser et de comprendre les meubles de salle de bain. Rien n'est occasionnel dans la collection STRONG, même les plus infimes détails sont analysés et considérés comme parfaits.

Sergio Luppi
baño





FLOOR 01

Width / Ancho / Largeur: 100 cm.
Finish / Acabado / Fini: 611 Blanco Alaska







FLOOR 02

Width / Ancho / Largeur: 120 cm.
Finish / Acabado / Fini: 620 Blanco Fin



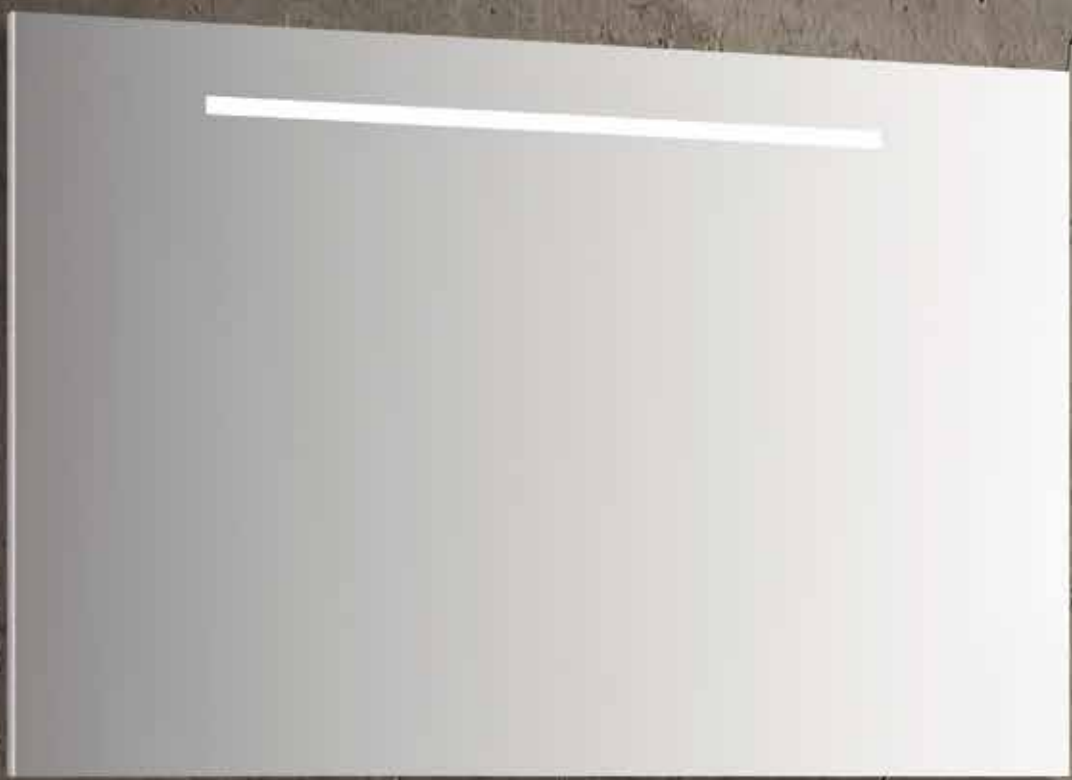



FLOOR 03

Width / Ancho / Largeur: 100 cm.
Finish / Acabado / Fini: 630 Ocaso



FLOOR 01. Pag. 68 - 69

↔ 100 cm.

 611 Alaska white
611 Blanco alaska
 611 Blanc alaska

UDS.	DESCRIPCIÓN / DESCRIPTION	PT.
1	Plv. 1 gaveta + 1 pta dcha + bancada - Floor. 87x100x45,5 cm. (Bancada acabado negro mate y mueble acabado 611). Plv. 1 drawer + 1 pta right + bench - Floor. (Matte black finish bench and 611 finished furniture). Plv. 1 tiroir + 1 pta droite + banc - Floor. (Banc de finition noir mat et mobilier fini 611).	XDD/780
1	Encimera Custom HPL, mecanizado L03. - 610 Nero Ingo. 1.2x101x46 cm. Custom HPL countertop, machining L03. / Comptoir HPL personnalisé, usinage L03.	YHL/263
-	Lavabo integrado custom. Built-in washbasin custom. / Lavabo intégré sur mesure.	L03/216
1	Espejo bastidor Titan cromo brillo. 70x100 cm. Titan frame mirror chrome shine. / Titan cadre miroir chrome brillant.	ECO/290
-	Retroiluminado luz superior. Backlit top light. / Lumière supérieure rétroéclairée.	105
1	Accesorio en Kit - Sense bath. Ancho 80 cm. Accessory in Kit - Sense bath. Width 80 cm. / Accessoire en Kit - Bain Sense. Largeur 80 cm.	TSB/124
TOTAL		FR01/1778

FLOOR 02. Pag. 70 - 71

↔ 120 cm.

 620 White fin
620 Blanco Fin.
 620 Blanc fin

UDS.	DESCRIPCIÓN / DESCRIPTION	PT.
1	Plv. 2 gavetas + 1 pta dcha + bancada - Floor. 87x120x45,5 cm. (Bancada acabado negro mate y mueble acabado 620). Plv. 2 drawers + 1 pta right + bench - Floor. (Matte black finish bench and 620 finished furniture). / Plv. 2 tiroirs + 1 pta droite + banc - Floor. (Banc de finition noir mat et mobilier fini 620).	XDE/983
1	Encimera Duroc, blanco nata, poza desplazada izquierda. 1,5x121x46 cm. Duroc countertop, cream white, left displaced pond. / Comptoir Duroc, blanc crème, bassin déplacé à gauche.	YST/242
-	Lavabo integrado poza A. Built-in washbasin for pool A. / Lavabo intégré pour la piscine A.	LPA/180
1	Espejo bastidor Titan cromo brillo. 70x120 cm. Titan frame mirror chrome shine. / Titan cadre miroir chrome brillant.	ECO/334
-	Retroiluminado luz superior. Backlit top light. / Lumière supérieure rétroéclairée.	105
1	Accesorio en Kit - Sense bath. Ancho 80 cm. Accessory in Kit - Sense bath. Width 80 cm. / Accessoire en Kit - Bain Sense. Largeur 80 cm.	TSB/124
TOTAL		FR02/1968



↔ 100 cm.

630 Sunset
630 Ocaso
630 Coucher de soleil

UDS.	DESCRIPCIÓN / DESCRIPTION	PT.
1	Plv. 2 gavetas + bancada - Floor. 87x100x45,5 cm. (Bancada acabado negro mate y mueble acabado 630). Plv. 2 drawers + bench - Floor. (Matte black finish bench and 630 finished furniture). Plv. 2 tiroirs + banc - Floor. (Banc de finition noir mat et mobilier fini 630).	XDB/825
1	Encimera Duroc, blanco nata, poza desplazada izquierda. 1,5x101x46 cm. Duroc countertop, cream white, left displaced pond. / Comptoir Duroc, blanc crème, bassin déplacé à gauche.	YST/202
-	Lavabo integrado poza A. Built-in washbasin for pool A. / Lavabo intégré pour la piscine A.	LPA/180
1	Espejo bastidor Titan cromo brillo. 70x100 cm. Titan frame mirror chrome shine. / Titan cadre miroir chrome brillant.	ECO/290
-	Retroiluminado luz superior. Backlit top light. / Lumière supérieure rétroéclairée.	105
TOTAL		FR03/1602

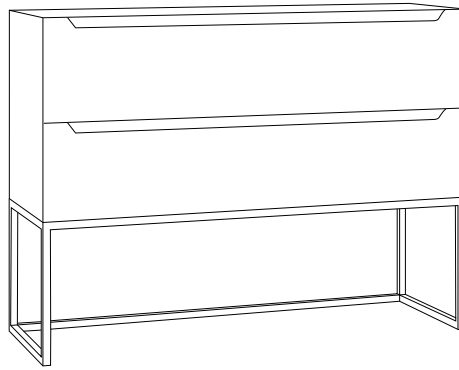

Plv. 2 equal drawers + bench Plv. 2 cajones iguales + bancada - Floor Plv. 2 tiroirs égaux + banc	
↓ 87 ↔ 60 x ↗ 45,5	XDB/723
↓ 87 ↔ 80 x ↗ 45,5	XDB/774
↓ 87 ↔ 100 x ↗ 45,5	XDB/825
↓ 87 ↔ 120 x ↗ 45,5	XDB/877

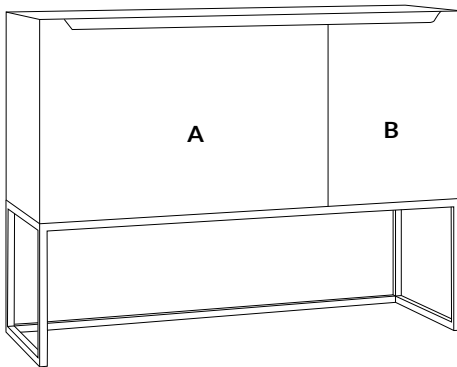

Plv. 1 drawer + 1 right door + bench Plv. 1 gaveta + 1 puerta derecha + bancada - Floor Plv. 1 tiroir + 1 porte droite + banc	
↓ 87 ↔ 80 x ↗ 45,5	XDD/725
↓ 87 ↔ 100 x ↗ 45,5	XDD/780
↓ 87 ↔ 120 x ↗ 45,5	XDD/834

Indicate right or left door.
Indicar puerta derecha o izquierda.
 Indiquez la porte droite ou gauche.

Internal drawer increment: + 90
Incremento cajón interior: + 90
 Incrément de tiroir interne: + 90

Measures CM width: Drawer (A) and Door (B) Medidas CM ancho: Gaveta (A) y Puerta (B) Mesures CM largeur: tiroir (A) et porte (B)		
A	B	A + B
550	250	800
650	350	1000
750	450	1200

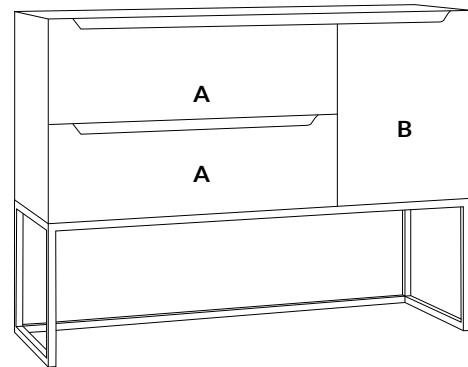

Plv. 2 equal drawers + 1 right door + bench Plv. 2 cajones iguales + 1 puerta derecha + bancada - Floor Plv. 2 tiroirs égaux + 1 porte droite + banc	
↓ 87 ↔ 80 x ↗ 45,5	XDE/869
↓ 87 ↔ 100 x ↗ 45,5	XDE/926
↓ 87 ↔ 120 x ↗ 45,5	XDE/983

Indicate right or left door.
Indicar puerta derecha o izquierda.
 Indiquez la porte droite ou gauche.

Measures CM width: Drawer (A) and Door (B) Medidas CM ancho: Gaveta (A) y Puerta (B) Mesures CM largeur: tiroir (A) et porte (B)		
A	B	A + B
550	250	800
650	350	1000
750	450	1200

BANCADA BENCH / BANQUES

FLOOR

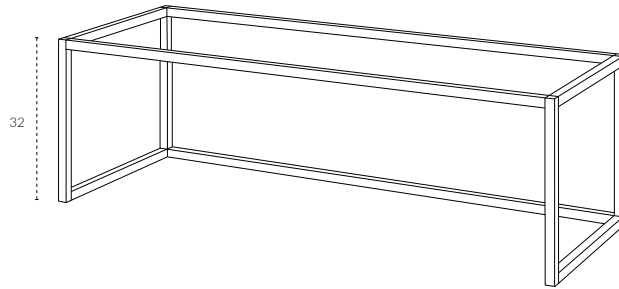

BNC bench Bancada BNC - Floor Banque BNC	
↓ 32 ↔ 60 x ↗ 45,5	X7L/218
↓ 32 ↔ 80 x ↗ 45,5	X7L/225
↓ 32 ↔ 100 x ↗ 45,5	X7L/237
↓ 32 ↔ 120 x ↗ 45,5	X7L/256

MUEBLES FURNITURES / MEUBLES

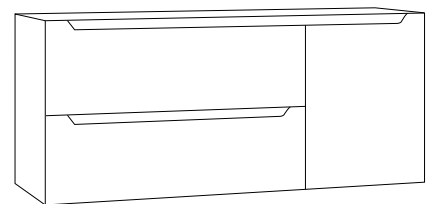
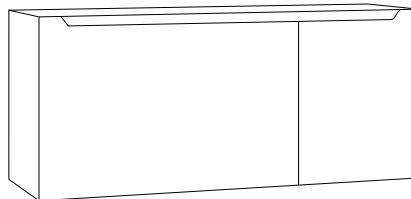
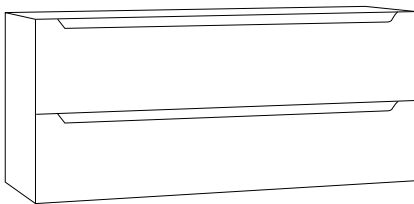

Plv. 2 equal drawers Plv. 2 cajones iguales Plv. 2 tiroirs égaux	
↓ 55 ↔ 60 x ↗ 45,5	XSH/596
↓ 55 ↔ 80 x ↗ 45,5	XSH/634
↓ 55 ↔ 100 x ↗ 45,5	XSH/672
↓ 55 ↔ 120 x ↗ 45,5	XSH/710

Plv. 1 drawer + 1 right door Plv. 1 gaveta + 1 puerta derecha Plv. 1 tiroir + 1 porte droite	
↓ 55 ↔ 80 x ↗ 45,5	XQZ/606
↓ 55 ↔ 100 x ↗ 45,5	XQZ/648
↓ 55 ↔ 120 x ↗ 45,5	XQZ/690

Plv. 2 equal drawers + 1 right door Plv. 2 cajones iguales + 1 puerta derecha Plv. 2 tiroirs égaux + 1 porte droite	
↓ 55 ↔ 80 x ↗ 45,5	XCR/752
↓ 55 ↔ 100 x ↗ 45,5	XCR/796
↓ 55 ↔ 120 x ↗ 45,5	XCR/841

Increase drawer interior in drawer: + 90
Incremento cajón interior en gaveta: + 90
 Augmenter l'intérieur du tiroir dans le tiroir: + 90

Compositions / **Composiciones** / Compositions



Structure finishes / **Acabados estructura** / Finitions structure



White
206-Met-Blanco
Blanc



Black
208-Met-Negro
Noir



Copper
200-Met-Cobre
Cuivre



Light grey
209-Met-Gris Claro
Gris clair

Fenix NMT finishes / **Acabados mueble Fenix NMT** / Fenix NMT finitions



620 Blanco fin / White fin / Blanc fin



621 Gris fin / Fin grey / Gris fin



622 Pizarra fin / Fin slate / Ardoise fin



630 Ocaso / Sunset / Coucher de soleil



631 Topacio / Topaz / Topaze



610 Nero ingo



611 Blanco alaska / Alaska white / Alaska blanc

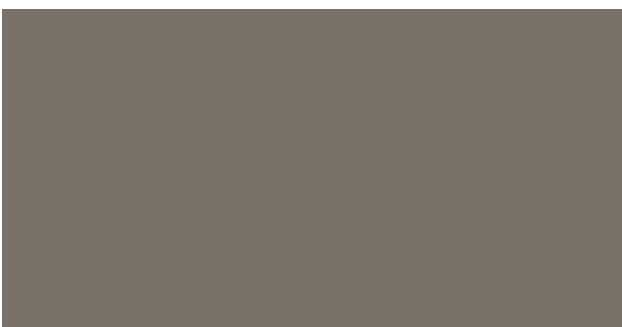

612 Grigio Ionora



613 Grigio bromo



**STR
ONG**
TWO FLOOR

CONEXIÓN
PERFECTA
ENTRE FUERZA Y
RESISTENCIA

PERFECT CONNECTION BETWEEN STRENGTH AND ENDURANCE / CONNEXION PARFAITE ENTRE FORCE ET ENDURANCE.

Auténtica síntesis entre fuerza y resistencia. Contraste, fusión, sofisticación, diseño con identidad propia, compleja mezcla con carácter actual e innovador.

True synthesis between strength and endurance. Contrast, fusion, sophistication, design identity, complex mixture with current and innovative character.

Synthèse authentique entre force et résistance. Contraste, fusion, sophistication, design avec sa propre identité, mélange complexe avec caractère actuel et innovant.

Sergio Luppi
baño





TWO FLOOR

Width / Ancho / Largeur: 80 cm.
Finish / Acabado / Fini: 631 Topacio





↔ 80 cm.

631 Topaz
631 Topacio
 631 Topaze

UDS.	DESCRIPCIÓN / DESCRIPTION	PT.
1	Plv. 2 cajones iguales + patas - Two Floor. (Patas acabado negro mate + mueble acabado 631) 87x80x45,5 cm. Plv. 2 equal drawers + legs - Two Floor. (Matte black finish legs + 631 finish cabinet) Plv. 2 tiroirs égaux + jambes - Two Floor. (Pieds finition noir mat + armoire finition 631)	XSE/758
1	Incremento toallero lateral. Lateral towel rail increment. / Incrément de porte-serviettes latéral.	50
1	Encimera Custom HPL mecanizado L02. 1,2x81x46 cm. Countertop custom HPL machined L02. / Comptoir sur mesure HPL usiné L02.	YHL/221
1	Lavabo cerámico de apoyo Rio. Ceramic washbasin Rio. / Lavabo en céramique Rio.	L02/130
1	Espejo bastidor Titan cromo brillo. 80x80 cm. Titan frame mirror chrome shine. / Titan cadre miroir chrome brillant.	ECO/277
-	Retroiluminado luz superior. Backlit top light. / Lumière supérieure rétroéclairée.	105
TOTAL		TF01/1531

UDS.	DESCRIPCIÓN AUXILIAR / AUXILIAR DESCRIPTION	PT.
1	Estantería alta 4 baldas. 140x40x20 cm. High shelving 4 shelves. / Haute étagère 4 étagères.	X7N/515
TOTAL CON AUXILIAR		TF01/2046

PACKS: MUEBLE + PATAS

PACKS: FURNITURE + LEGS / PACKS: MEUBLES + PIEDS

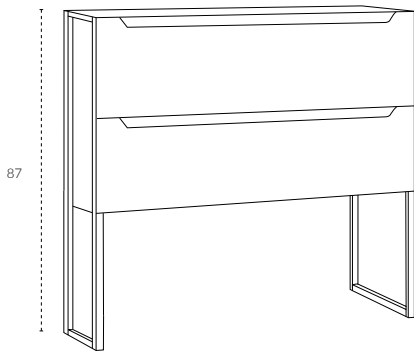

Plv. 2 equal drawers + legs Plv. 2 cajones iguales + patas - Two Floor Plv. 2 tiroirs égaux + jambes	
↓ 87 ↔ 60 x ∅ 45,5	XSE/709
↓ 87 ↔ 80 x ∅ 45,5	XSE/758
↓ 87 ↔ 100 x ∅ 45,5	XSE/808
↓ 87 ↔ 120 x ∅ 45,5	XSE/858

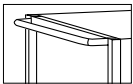

Lateral towel rail increment: + 50
Incremento toallero lateral: + 50
Incrément de porte-serviettes latéral: + 50

AUXILIAR / AUXILIARIE

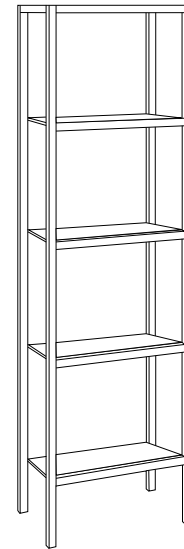

High shelving 4 shelves Estantería alta 4 baldas Haute étagère 4 étagères	
↓ 140 ↔ 30 x ∅ 20	X7N/500
↓ 140 ↔ 40 x ∅ 20	X7N/515
↓ 140 ↔ 50 x ∅ 20	X7N/539
↓ 140 ↔ 60 x ∅ 20	X7N/578

PATAS LEGS / PIEDS

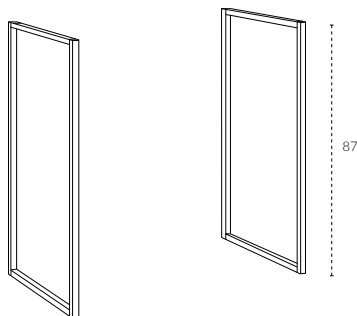

Legs Patas - Two Floor Pieds	
∅ 46	8ME/135

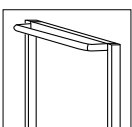

Lateral towel rail increment: + 50
Incremento toallero lateral: + 50
Incrément de porte-serviettes latéral: + 50
Minimum towel measure: 420 mm
Medida mínima toallero: 420 mm
Mesure de serviette minimale: 420 mm

MUEBLE FURNITURE / MEUBLE



Plv. 2 equal drawers Plv. 2 cajones iguales Plv. 2 tiroirs égaux	
↓ 55 ↔ 60 x ∅ 45,5	XSH/596
↓ 55 ↔ 80 x ∅ 45,5	XSH/634
↓ 55 ↔ 100 x ∅ 45,5	XSH/672
↓ 55 ↔ 120 x ∅ 45,5	XSH/710

Compositions / **Composiciones** / Compositions

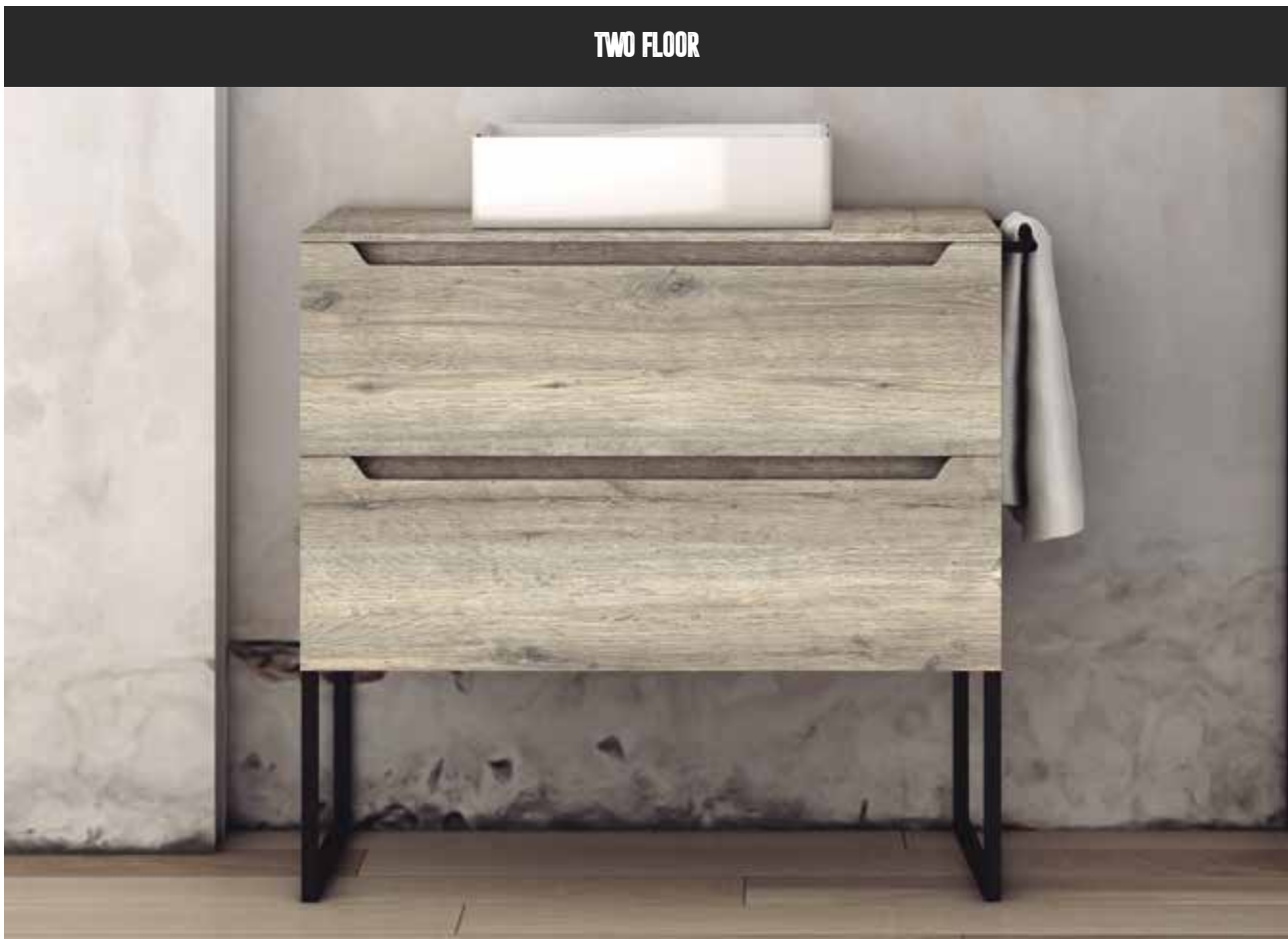

Structure finishes / **Acabados estructura** / Finitions structure

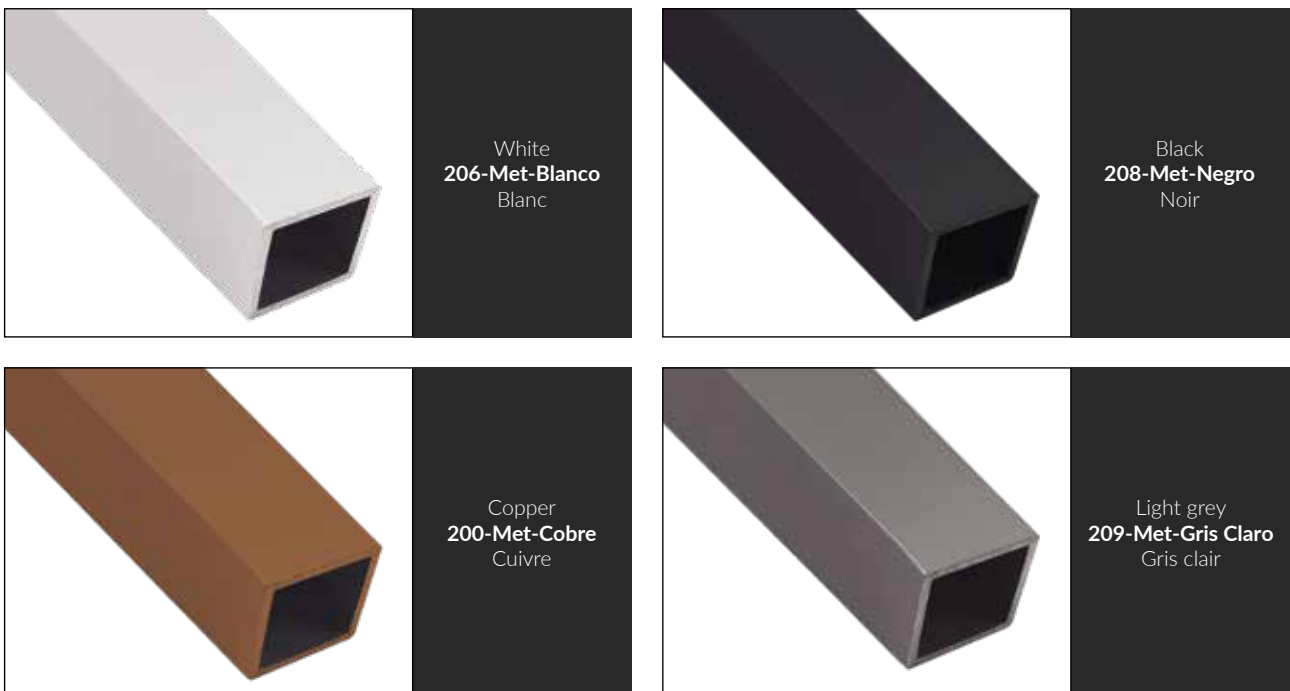

Fenix NMT finishes / **Acabados mueble Fenix NMT** / Fenix NMT finitions



620 Blanco fin / White fin / Blanc fin



621 Gris fin / Fin grey / Gris fin



622 Pizarra fin / Fin slate / Ardoise fin



630 Ocaso / Sunset / Coucher de soleil



631 Topacio / Topaz / Topaze



610 Nero ingo



611 Blanco alaska / Alaska white / Alaska blanc

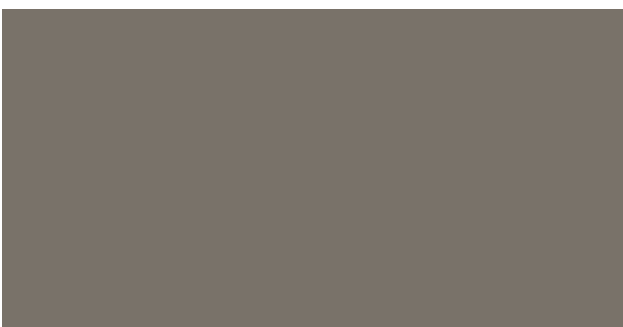

612 Grigio Ionora



613 Grigio bromo



**STR
ONG**
COMPLEMENTS

EXCELENTE
SIMBIOSIS DE
DUREZA, CALIDAD Y
ESTILO PARA EL BAÑO

PERFECT CONNECTION BETWEEN STRENGTH AND ENDURANCE / CONNEXION PARFAITE ENTRE FORCE ET ENDURANCE.

Auténtica síntesis entre fuerza y resistencia. Contraste, fusión, sofisticación, diseño con identidad propia, compleja mezcla con carácter actual e innovador.

True synthesis between strength and endurance. Contrast, fusion, sophistication, design identity, complex mixture with current and innovative character.

Synthèse authentique entre force et résistance. Contraste, fusion, sophistication, design avec sa propre identité, mélange complexe avec caractère actuel et innovant.

Sergio Luppi
baño

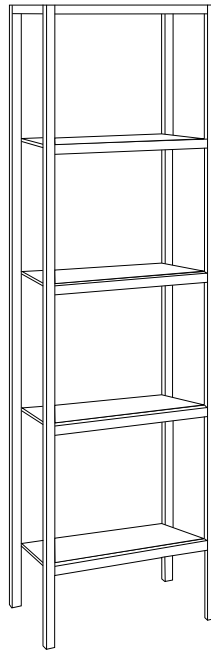

High shelving 4 shelves Estería alta 4 baldas Haute étagère 4 étagères	
↓ 140 ↔ 30 x ↗ 20	X7N/500
↓ 140 ↔ 40 x ↗ 20	X7N/515
↓ 140 ↔ 50 x ↗ 20	X7N/539
↓ 140 ↔ 60 x ↗ 20	X7N/578

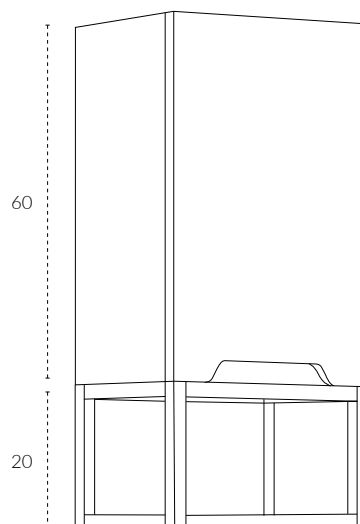

High 1 right door + auxiliary shelf support Alto 1 puerta derecha + soporte repisa auxiliar High 1 porte droite + support auxiliaire	
↓ 80 ↔ 30 x ↗ 20	XBM/353
↓ 80 ↔ 40 x ↗ 20	XBM/376
↓ 80 ↔ 50 x ↗ 20	XBM/389

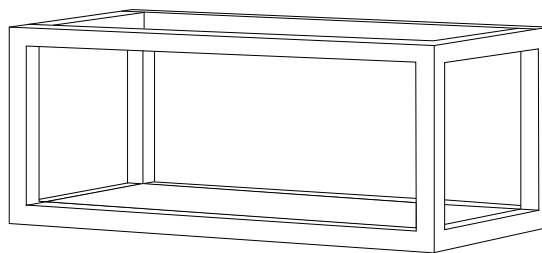

Auxiliary shelf support Soporte repisa auxiliar Support d'étagère auxiliaire	
↓ 20 ↔ 30 x ↗ 17	X7P/200
↓ 20 ↔ 40 x ↗ 17	X7P/210
↓ 20 ↔ 50 x ↗ 17	X7P/221
↓ 20 ↔ 60 x ↗ 17	X7P/237

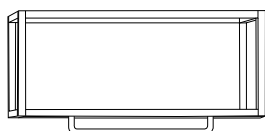

Towel rack: + 50
Toallero: + 50
Porte-serviettes: + 50

Minimum towel measure: 420 mm
Medida mínima toallero: 420 mm
Mesure de serviette minimale: 420 mm

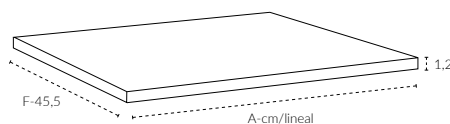

Top cm / lineal Tapa cm / lineal Couverture cm / linéaire
XTD/1.25

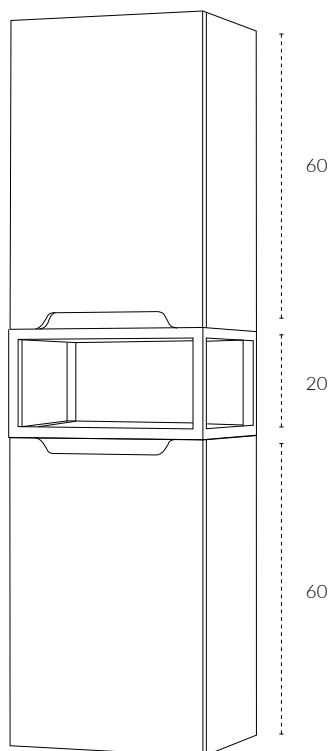

Semi column 1 door + auxiliary shelf support + 1 door Semi columna 1 puerta + soporte repisa auxiliar + 1 puerta Semi colonne 1 porte + support de tablette auxiliaire + 1 porte	
↓ 140 ↔ 30 x ↗ 20	XSU/512
↓ 140 ↔ 40 x ↗ 20	XSU/529
↓ 140 ↔ 50 x ↗ 20	XSU/545

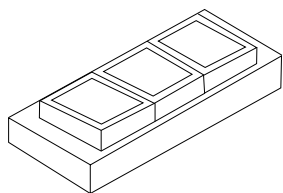

Side accessory with plastic cubes Accesorio lateral con cubos plásticos Accessoire latéral avec des cubes en plastique	
Cubes Cubos Cubes	UD.
3	CSB/16

F-31 = 2 cubes / F-37 or 43 = 3 cubes
F-31 = 2 cubos / F-37 o 43 = 3 cubos
 F-31 = 2 cubes / F-37 ou 43 = 3 cubes

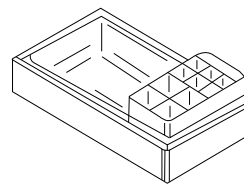

Accessory with cosmetic storage tray Accesorio con bandeja de almacenaje cosméticos Accessoire avec bac à cosmétiques	
↔ cm	UD.
14	CSE/16

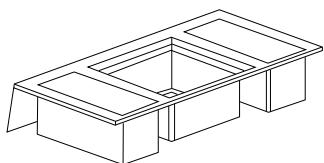

Side bucket container 5 LTS Lateral contenedor cubo 5 LTS Conteneur à godets latéraux 5 LTS	
UD.	
CSA/56	

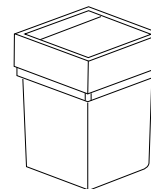

5 LTS bucket with revolving lid Cubo 5 LTS con tapa giratoria Seau 5 LTS avec couvercle tournant	
UD.	
CSG/24	

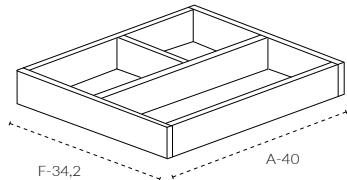

Cosmetic separator for furniture F-46 Separador cosmético para muebles F-46 Séparateur cosmétique por meuble F-46		
↔ cm	Separator width Ancho separador Largeur du séparateur	UD.
70	20	CSC/28
80	25	CSC/32
90	30	CSC/36
100	35	CSC/40



Organizer tray siphon P.LV. Bandeja organizador sifón P.LV. Plateau organisateur siphon P.LV.	
Width up Anchura hasta Largeur	UD.
90	CSB/89
120	CSB/115

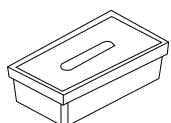

Kleenex box Porta kleenex Boîte Kleenex	
UD.	
CSF/16	

ACCESORIOS EN KIT - SENSE BATH
 ACCESSORIES IN KIT - SENSE BATH / ACCESSOIRES EN KIT - SENSE BATH

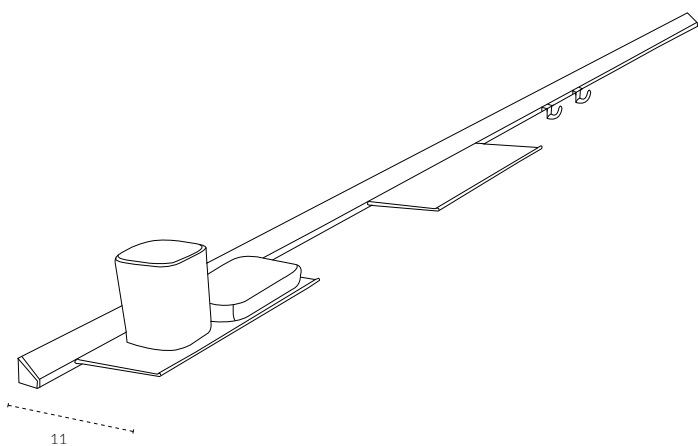

Bar width 80/100 cm. / Barra de ancho 80/100 cm. / Largeur de barre 80/100 cm.	
Milled shelf / Estante perforado / Étagère perforée	
Ceramic vessel / Vaso cerámico / Récipient en céramique	
Ceramic soap dish / Jabonera cerámico / Porte savon en céramique	
Shelf / Estante / Étagère	
2 hooks / 2 ganchos / 2 crochets	
Kit ↔ 80 cm - Sense Bath aluminio	TSB/124
Kit ↔ 100 cm - Sense Bath aluminio	TSB/129

11

ACCESORIOS EN KIT - SENSE TOILET BASIC
 ACCESSORIES IN KIT - SENSE TOILET BASIC / ACCESSOIRES EN KIT - SENSE TOILET BASIC

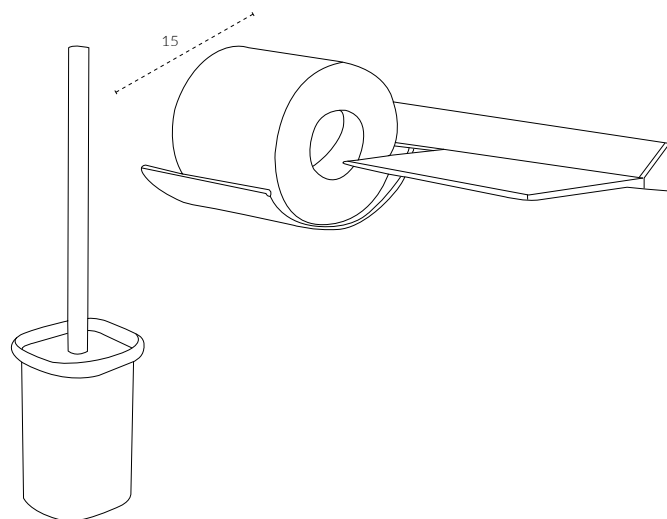

Bar width 30 cm. / Barra de ancho 30 cm. / Largeur de barre 30 cm.	
Shelf / Estante / Étagère	
Roll holder / Porta rollo / Porte-rouleau	
Ceramic toilet brush holder / Escobillero cerámico / Porte-brosse de toilette en céramique	
Kit ↔ 30 cm - Sense Bath aluminio	TSB/106

ESPEJOS BASTIDOR
FRAME MIRRORS / MIROIRS DE CADRE

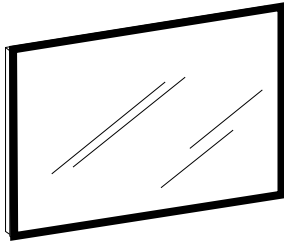

Painted finishes: Black - White - Copper - Gray
Acabados pintados: Negro - Blanco - Cobre - Gris
Finitions peintes: Noir - Blanc - Cuivre - Gris

THOR: Mirror frame metal structure THOR: Espejo bastidor estructura metálica THOR: Structure métallique du cadre du miroir		
cm	Painted epoxy / Pintados epoxi / Epoxy peint	
↓ 70 ↔ 60 x ↗ 3	EEC/159	
↓ 70 ↔ 80 x ↗ 3	EEC/168	
↓ 70 ↔ 100 x ↗ 3	EEC/187	
↓ 70 ↔ 120 x ↗ 3	EEC/208	
↓ 70 ↔ 140 x ↗ 3	EEC/232	

From height 70 up to height 80: +19 / 10 mm bezel: +22
Desde altura 70 hasta altura 80: +19 / Bisel de 10 mm: +22
De la hauteur 70 à la hauteur 80: +19 / 10 mm lunette: +22

Increase option / **Opción incremento** / Option d'augmentation

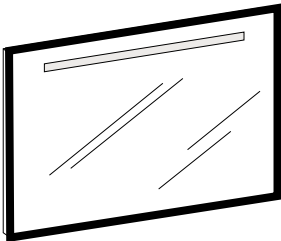

Upper light backlight: +105
Retroiluminación luz superior: +105
Rétro-éclairage supérieur: +105

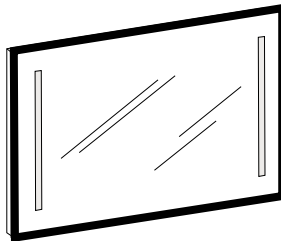

Side light backlighting: +150
Retroiluminación luz laterales: +150
Rétro-éclairage latéral: +150

Anti-fog plate option Opción placa anti-vaho Option anti-buée		
cm	Points / Puntos	
De 80 a 100	EVO/044	
De 120 a 140	EVO/084	

TITAN

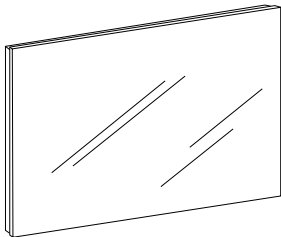

URION

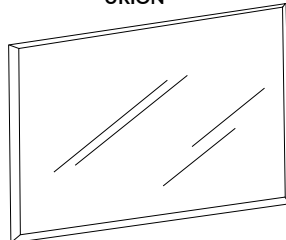

Available wall lamps: Domos and Karin
Appliques disponibles: Domos y Karin
Appliques disponibles: Domos et Karin

TITAN AND URION: Straight and shaped aluminium frame mirrors TITAN Y URION: Espejos bastidor aluminio recto y con forma TITAN AND URION: Miroirs à cadre en aluminium droits et profilés			
cm	Shining chrome / Cromo brillo / Chrome brillant	Painted epoxy / Pintados epoxi / Epoxy peint	
↓ 70 ↔ 60 x ↗ 3	ECO/238	ECO/277	
↓ 70 ↔ 80 x ↗ 3	ECO/255	ECO/295	
↓ 70 ↔ 100 x ↗ 3	ECO/290	ECO/330	
↓ 70 ↔ 120 x ↗ 3	ECO/334	ECO/373	
↓ 70 ↔ 140 x ↗ 3	ECO/377	ECO/417	

Painted finishes: Black - White - Copper - Gray
Acabados pintados: Negro - Blanco - Cobre - Gris
Finitions peintes: Noir - Blanc - Cuivre - Gris

From height 70 up to height 80: +22 / 10 mm bezel: +22
Desde altura 70 hasta altura 80: +22 / Bisel de 10 mm: +22
De la hauteur 70 à la hauteur 80: +22 / 10 mm lunette: +22

Increase option / **Opción incremento** / Option d'augmentation

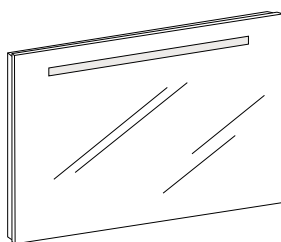

Upper light backlight: +105
Retroiluminación luz superior: +105
Rétro-éclairage supérieur: +105

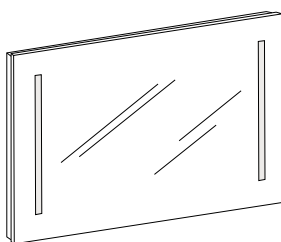

Side light backlighting: +150
Retroiluminación luz laterales: +150
Rétro-éclairage latéral: +150

Anti-fog plate option Opción placa anti-vaho Option anti-buée		
cm	Points / Puntos	
De 80 a 100	EVO/044	
De 120 a 140	EVO/084	

APLIQUES LED

LED APPLIQUES / LED APPLIQUES

ÁFRICA

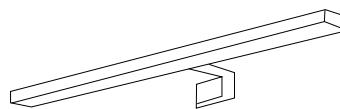

- Africa width 30 and 45 cm: 4.8W - LED 330LM - 4000K.
- Africa width 60 cm: 9.6W - LED 750LM - 4000K.

- **Africa ancho 30 y 45 cm: 4.8W - LED 330LM - 4000K.**
- **Africa ancho 60 cm: 9.6W - LED 750LM - 4000K.**

- Largeur Afrique 30 et 45 cm: 4.8W - LED 330LM - 4000K.
- Largeur Afrique 60 cm: 9,6W - LED 750LM - 4000K.

A10		
↔ cm	Chrome / Cromo	Black / Negro / Noir
30	A10/59	A10/65
45	A10/69	A10/75
60	A10/112	A10/118

DOMOS

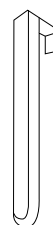

- Domes: 12W - LED 390LM - 3000K.
- External driver.

- **Domos: 12W - LED 390LM - 3000K.**
- **Driver externo.**

- Dômes: 12W - LED 390LM - 3000K.
- Pilote externe.

A07	
↓ cm	Points / Puntos
28	A07/120

KARIN



- Karin width 30 cm: 6W - LED 600LM - 5700K.
- Karin width 50 cm: 6W - LED 748LM - 5700K.
- External driver.

- **Karin ancho 30 cm: 6W - LED 600LM - 5700K.**
- **Karin ancho 50 cm: 6W - LED 748LM - 5700K.**
- **Driver externo.**

- Largeur Karin 30 cm: 6W - LED 600LM - 5700K.
- Largeur Karin 50 cm: 6W - LED 748LM - 5700K.
- Pilote externe.

A18	
↔ cm	Points / Puntos
30	A18/112
50	A18/127

LUNAR

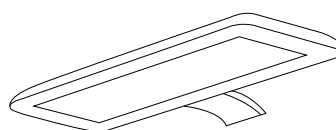

- Lunar width 30 cm: 10W - LED 300LM - 1860K.

- **Lunar ancho 30 cm: 10W - LED 300LM - 1860K.**

- Largeur Lunar 30 cm: 10W - LED 300LM - 1860K.

A24		
↔ cm	White / Blanco / Blanc	Black / Negro / Noir
30	A24/85	A24/95



**STR
ONG**

LAVABOS

STRONG, UNA COLECCIÓN UNICA CON CARÁCTER

STRONG, HARDNESS AND / STRONG, DURETÉ ET SYMBOLE ACTUEL.

Detalles cautivadores, exclusivos, refinados, con gran personalidad y carácter que irrumpen con fuerza, despertando sensaciones y emociones, una dureza y actualidad que determinan la complejidad del mobiliario.

Captivating details, exclusive, refined, with great personality and character that burst with strength, awakening sensations and emotions, hardness and topicality that determines the complexity of the furniture.

Des détails captivants, exclusifs, raffinés, avec une grande personnalité et caractère qui éclatent de force, éveillent des sensations et des émotions, dureté et actualité qui déterminent la complexité du mobilier.

Sergio Luppi
baño

Select washbasin / **Selecciona lavabo** / Sélectionnez le lavabo

1

SOLID SURFACE		
Integrated washbasin Lavabo integrado Lavabo intégré	Built-in washbasin Lavabo encastrado Lavabo encastré	Washbasin Lavabo de apoyar Lavabo

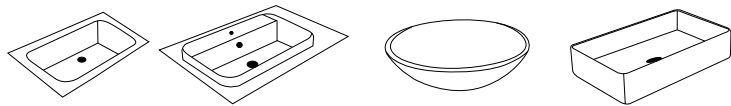

CERAMIC/ CERÁMICOS / CÉRAMIQUE	
Washbasin Lavabo de apoyar Lavabo	

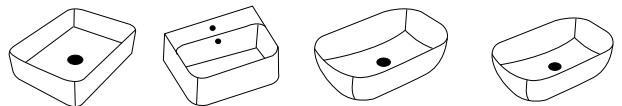

CUSTOM - L03	KIMI - L27	ROUND - L16	POU - L19
↓ 12 ↔ 50 x ↗ 30	↓ 14,3 ↔ 55 x ↗ 39	↓ 13 ↔ 40 x ↗ 40	↓ 13 ↔ 58 x ↗ 37
L03/216	Matt / Mate Gloss / Brillo / Brillant L27/165 L27/198	Matt / Mate Gloss / Brillo / Brillant L16/192 L16/197	Matt / Mate Gloss / Brillo / Brillant L19/240 L19/245

RIO - L02	KOMI - L28	FINO - L45	FLAT - L05
↓ 13 ↔ 46 x ↗ 36	↓ 13 ↔ 42 x ↗ 42	↓ 14,5 ↔ 60,5 x ↗ 40	↓ 13,5 ↔ 45,5 x ↗ 32,5
L02/130	L28/173	L45/173	L05/130

KIMI - L27	
↓ 14,5 ↔ 75 x ↗ 39	
Matt / Mate	Gloss / Brillo / Brillant
L27/170	L27/203

Select countertop and measurements
Selecciona encimera y medidas
Sélectionner le comptoir et les mesures

2

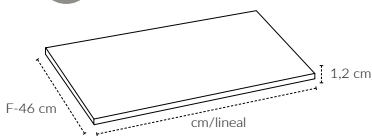

↔ cm/lineal	↗ 46,5 cm	↗ 51 cm
↓ 1,2	YHL/2,6	YHL/2,7

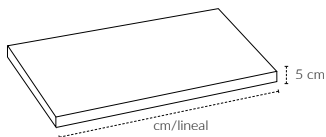

↔ cm/lineal	↗ 46,5 cm	↗ 51 cm
↓ 5	YHL/4	YHL/4,10

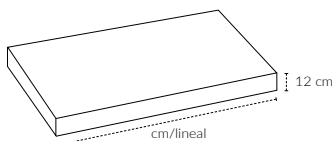

↔ cm/lineal	↗ 46,5 cm	↗ 51 cm
↓ 12	YHL/4,10	YHL/4,20

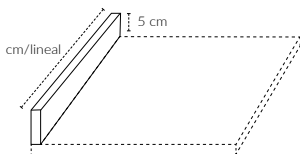

↔ cm/lineal	↗ 46,5 cm
↓ 5	YCO/0,8

Select finish
Selecciona acabado
Sélectionnez la finition

3

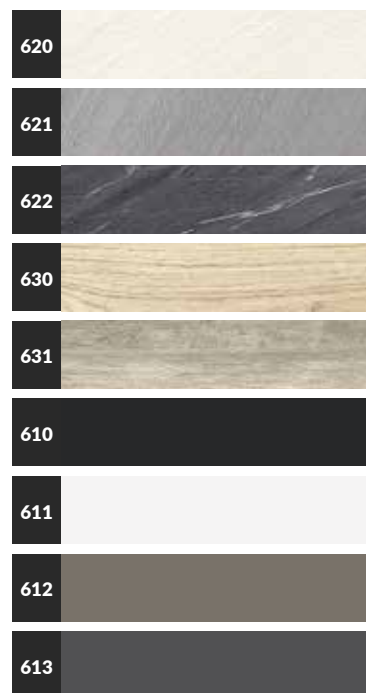

Select add-on / **Selecciona complemento** / Sélectionnez add-on

4

Towel rack: + 50 points
Toallero: + 50 puntos
Porte-serviettes: + 50 points



H04 - Supports for skirt 12 cm: 26 UD.
H04 - Soportes para faldón ↓ 12 cm: 26 UD.
H04 - Supports pour jupe 12 cm: 26 UD.



H02 - Supports for 5 cm skirt: 33 UD.
H02 - Soportes para faldón ↓ 5 cm: 33 UD.
H02 - Supports pour jupe de 5 cm: 33 UD.



Clicker chrome valve: 5S16/022
Válvula Clicker cromo: 5S16/022
Valve chrome à Clicker: 5S16/022
Clicker ceramic valve: 5S18/030
Válvula cerámico Clicker: 5S18/030
Valve céramique clicker: 5S18/030



Rubi Clicker valve
matte or gloss: 5S17/050
Válvula Clicker Rubi
mate ó brillo: 5S17/050
Clapet à Clicker Rubi
mat ou brillant: 5S17/050



Select washbasin / **Selecciona lavabo** / Sélectionnez le lavabo

1

POZA AUTO LAVABO			
Types of pools Tipos de poza Types de piscines			

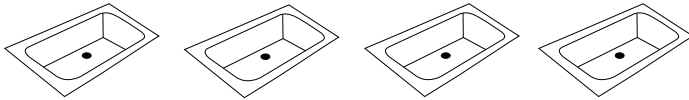

POZA A - LPA	POZA C - LPC	POZA B - LPB	POZA R - LPR
↓ 12 ↔ 52 ↗ 29,5	↓ 9 ↔ 40,5 ↗ 29,5	↓ 9 ↔ 48,5 ↗ 29,5	↓ 9 ↔ 40,5 ↗ 22,5
LPA/180	LPC/180	LPB/180	LPR/180

WASHBASIN / LAVABO DE APOYAR / LAVABO		
NUSS		

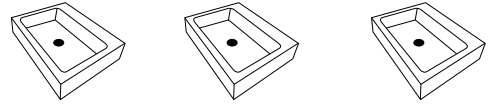

POZA B - NUSS L25	POZA C - NUSS L25	POZA R - NUSS L25
↓ 9 ↔ 48,5 ↗ 29,5 Washbasin / Lavabo: ↓ 12 ↔ 56 ↗ 43	↓ 9 ↔ 40,5 ↗ 28,5 Washbasin / Lavabo: ↓ 12 ↔ 48 ↗ 41	↓ 9 ↔ 40,5 ↗ 22,5 Washbasin / Lavabo: ↓ 12 ↔ 48 ↗ 35
L25/336	L25/361	L25/392

Select countertop and measurements
Selecciona encimera y medidas
Sélectionner le comptoir et les mesures

2

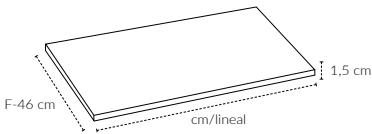

↔ cm/lineal	↗ 46,5 cm	↗ 51 cm
↓ 1,5	YST/2	YST/2.05

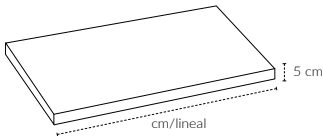

↔ cm/lineal	↗ 46,5 cm	↗ 51 cm
↓ 5	YST/3.4	YST/3.45

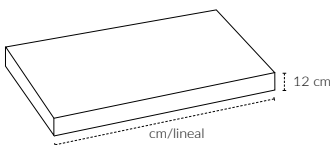

↔ cm/lineal	↗ 46,5 cm	↗ 51 cm
↓ 12	YST/3.45	YST/3.5

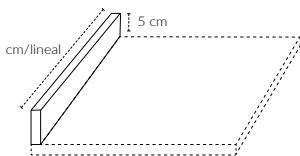

↔ cm/lineal	↓ 5
↓ 5	YCO/0.55

Select finish
Selecciona acabado
Sélectionnez la finition

3

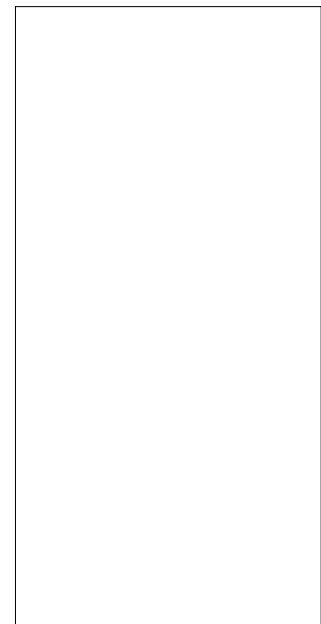

Blanco nata / Cream white / Blanc crème

Select add-on / **Selecciona complemento** / Sélectionnez add-on

4

Towel rack: + 50 points
Toallero: + 50 puntos
Porte-serviettes: + 50 points



H04 - Supports for skirt 12 cm: 26 UD.
H04 - Soportes para faldón ↓ 12 cm: 26 UD.
H04 - Supports pour jupe 12 cm: 26 UD.



H02 - Supports for 5 cm skirt: 33 UD.
H02 - Soportes para faldón ↓ 5 cm: 33 UD.
H02 - Supports pour jupe de 5 cm: 33 UD.



Clicker chrome valve: 5SI6/022
Válvula Clicker cromo: 5SI6/022
Valve chrome à Clicker: 5SI6/022

Clicker white cream valve: 5SI6/036
Válvula Clicker blanco nata: 5SI6/036
Valve à crème blanche Clicker: 5SI6/036



Select washbasin / **Selecciona lavabo** / Sélectionnez le lavabo

SOLID SURFACE	
Built-in washbasin Lavabo encastrado Lavabo encastré	Washbasin Lavabo de apoyar Lavabo

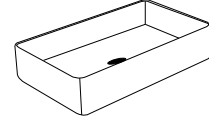
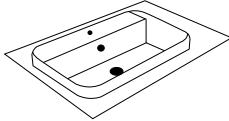

KIMI - L27	
↓ 14,3 ↔ 55 x ↗ 39	
Matt / Mate	Gloss / Brillo / Brillant
L27/165	L27/198

KIMI - L27	
↓ 14,5 ↔ 75 x ↗ 39	
Matt / Mate	Gloss / Brillo / Brillant
L27/170	L27/203

ROUND - L16	
↓ 15 ↔ 40 x ↗ 40	
Matt / Mate	Gloss / Brillo / Brillant
L16/192	L16/197

POU - L19	
↓ 13 ↔ 58 x ↗ 37	
Matt / Mate	Gloss / Brillo / Brillant
L19/240	L19/245

Select countertop and measurements
Selecciona encimera y medidas
Sélectionner le comptoir et les mesures

Select finish
Selecciona acabado
Sélectionnez la finition

2

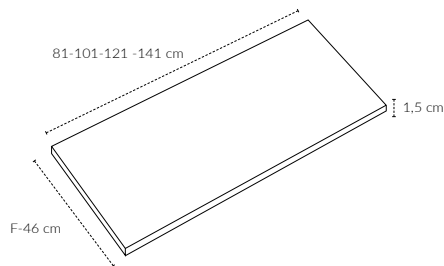

1 draft for washbasin 1 calado para lavabo 1 projet pour lavabo		
↔ cm	Matt / Mate	Gloss / Brillo / Brillant
81	YER/147	YER/152
101	YER/183	YER/188
121	YER/207	YER/212
141	YER/231	YER/236



Blanco mate / Matt white / Blanc mate



Blanco brillo / Gloss white / Blanc brillant

3

Select add-on / **Selecciona complemento** / Sélectionnez add-on

4

Increase wide cut - Matte finish: + 50
Incremento corte ancho - Acabado mate: + 50
Augmenter la coupe large - Finition mate: + 50

Wide cut increase - gloss finish: + 80
Incremento corte ancho - Acabado brillo: + 80
Augmentation de la coupe large - finition brillante: + 80

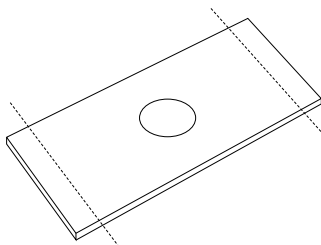

Clicker chrome valve: 5SI6/022
Válvula Clicker cromo: 5SI6/022
Valve chrome à Clicker: 5SI6/022

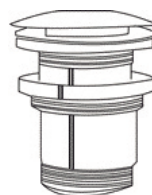

Rubi Clicker valve matte or gloss: 5SI7/050
Válvula Clicker Rubi mate ó brillo: 5SI7/050
Clapet à Clicker Rubi mat ou brillant: 5SI7/050

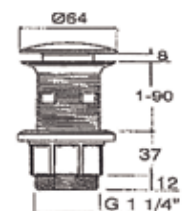

LM14

LAVABO SOLID DE APOYAR KIARA RUBI

LAVABO SOLID OF SUPPORT KIARA RUBI / LAVABO SOLIDE DE SOUTIEN KIARA RUBI

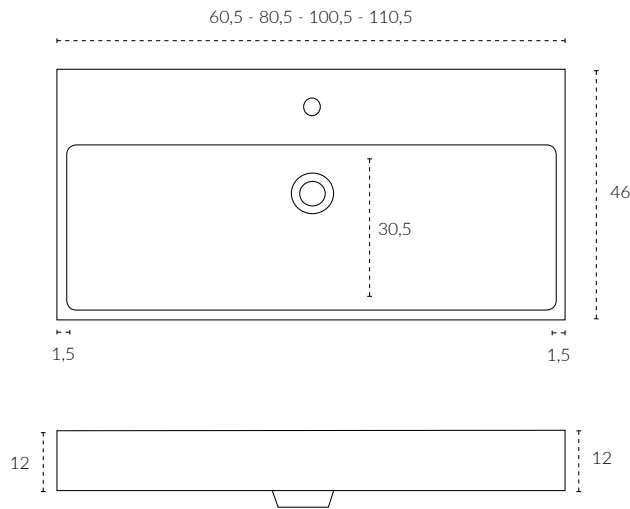

KIARA - LM14		
↔ cm	White Matt / Blanco Mate / Blanc mate	White gloss / Blanco brillo / Blanc Brillant
60,5	LM14/227	LM14/233
80,5	LM14/274	LM14/280
100,5	LM14/321	LM14/326
110,5	LM14/344	LM14/349

LM15

LAVABO SOLID DE APOYAR KIARA RUBI

LAVABO SOLID OF SUPPORT KIARA RUBI / LAVABO SOLIDE DE SOUTIEN KIARA RUBI

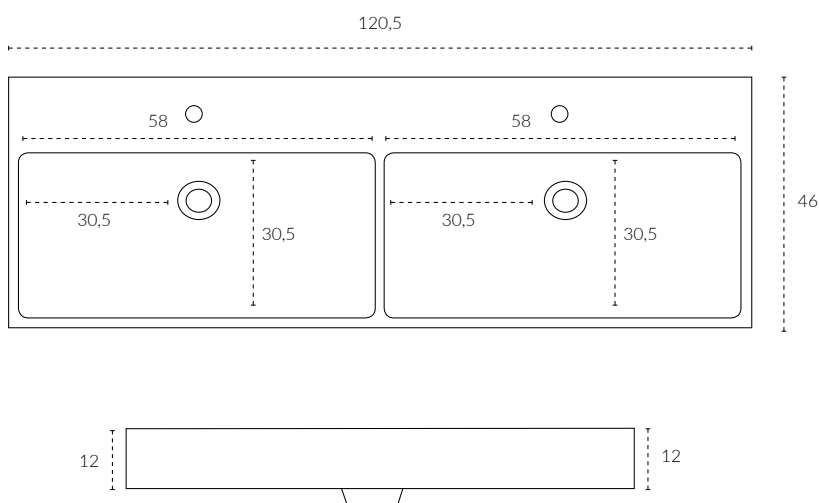

Clicker chrome valve: 5SI6/022
Válvula Clicker cromo: 5SI6/022
 Valve chrome à Clicker: 5SI6/022



Rubi Clicker valve matte or gloss: 5SI7/050
Válvula Clicker Rubi mate ó brillo: 5SI7/050
 Clapet à Clicker Rubi mat ou brillant: 5SI7/050

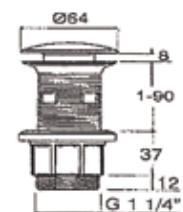

KIARA - LM15		
↔ cm	White Matt / Blanco Mate / Blanc mate	White gloss / Blanco brillo / Blanc Brillant
120,5	LM15/370	LM15/375

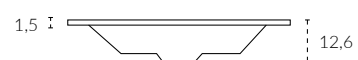
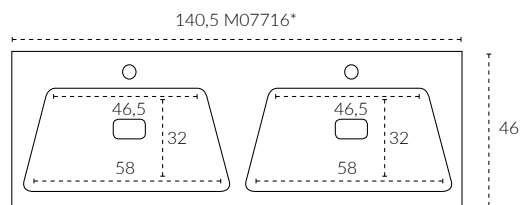
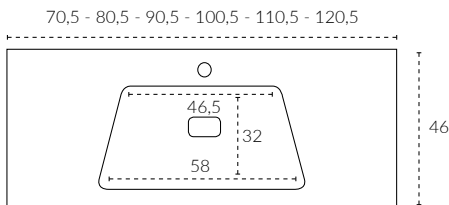
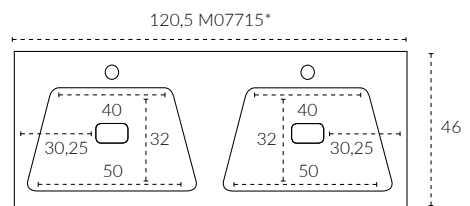
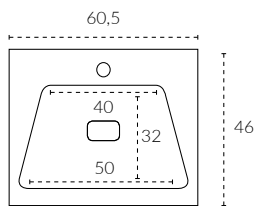

Centred washbasin / Poza centrada / Vasque centrée		
↔ cm	Matt / Mate	Gloss / Brillo / Brillant
60,5	YS1/195	YS1/200
70,5	YS1/237	YS1/242
80,5	YS1/249	YS1/254
90,5	YS1/261	YS1/266
100,5	YS1/279	YS1/284
110,5	YS1/300	YS1/305
120,5	YS1/321	YS1/326

Double washbasin / Doble poza / Double vasques		
↔ cm	Matt / Mate	Gloss / Brillo / Brillant
120,5	YS1/378	YS1/383
140,5	YS1/399	YS1/404

* INC. Cut back box or shape in matte finish: +50 UD.
***INC. Corte caja trasera o forma en acabado mate: +50 UD.**
* INC. Découpe ou forme en finition mate: +50 UD.

* INC. Cut back box or shape in gloss finish: +80 UD.
***INC. Corte caja trasera o forma en acabado brillo: +80 UD.**
* INC. Découpe ou forme en brillant: +80 UD.

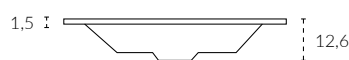
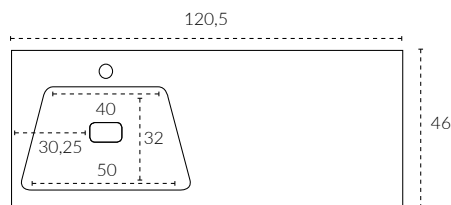
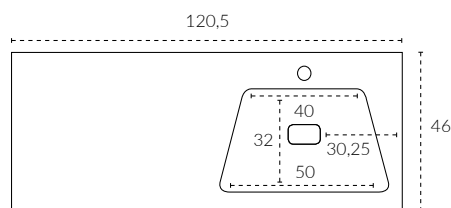

Asymmetric washbasin / Poza desplazada / Vasque asymétrique		
↔ cm	Matt / Mate	Gloss / Brillo / Brillant
120,5	YS1/321	YS1/326

* INC. Cut back box or shape in matte finish: +50 UD.
***INC. Corte caja trasera o forma en acabado mate: +50 UD.**
* INC. Découpe ou forme en finition mate: +50 UD.

* INC. Cut back box or shape in gloss finish: +80 UD.
***INC. Corte caja trasera o forma en acabado brillo: +80 UD.**
* INC. Découpe ou forme en brillant: +80 UD.



ENCIMERA AUTO LAVABO SOLID KEISI RUBI (poza centrada o doble poza)

SOLID KEISI COUNTERTOPS / COMPTOIRS SOLID KEISI RUBI

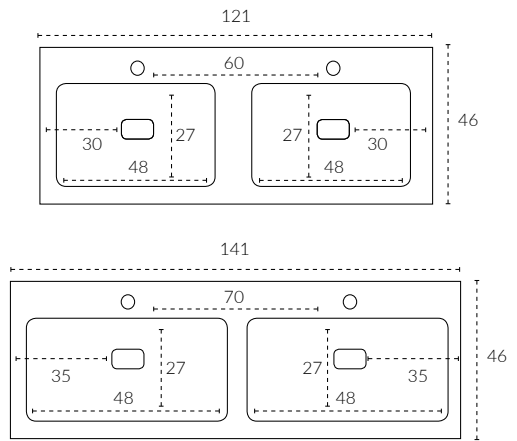
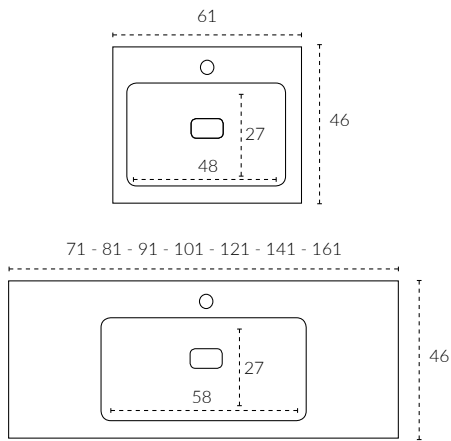

Centred washbasin / Poza centrada / Vasque centrée		
↔ cm	Matt / Mate	Gloss / Brillo / Brillant
61	YSR/162	YSR/167
71	YSR/198	YSR/203
81	YSR/213	YSR/218
91	YSR/231	YSR/236
101	YSR/240	YSR/245
121	YSR/282	YSR/287
141	YSR/439	YSR/444
161	YSR/512	YSR/517

Double washbasin / Doble poza / Double vasques		
↔ cm	Matt / Mate	Gloss / Brillo / Brillant
121	YSR/352	YSR/357
141	YSR/372	YSR/377

* INC. Cut back box or shape in matte finish: +50 UD.
***INC. Corte caja trasera o forma en acabado mate: +50 UD.**
 * INC. Découpe ou forme en finition mate: +50 UD.

* INC. Cut back box or shape in gloss finish: +80 UD.
***INC. Corte caja trasera o forma en acabado brillo: +80 UD.**
 * INC. Découpe ou forme en brillant: +80 UD.



ENCIMERA AUTO LAVABO SOLID KEISI RUBI (poza desplazada)

SOLID KEISI COUNTERTOPS / COMPTOIRS SOLID KEISI RUBI

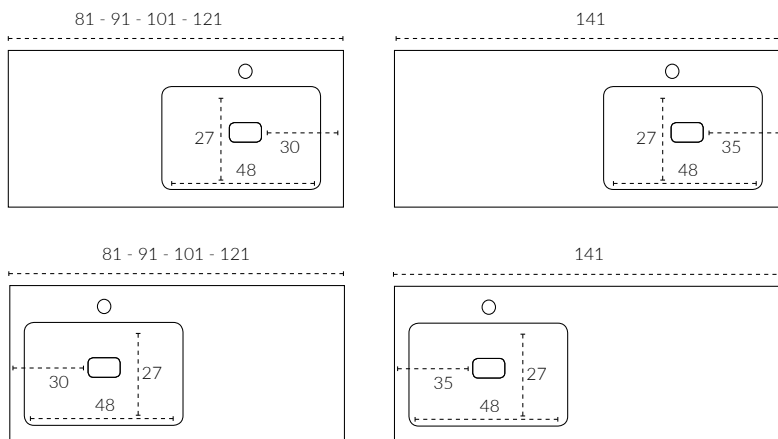

Asymmetric washbasin / Poza desplazada / Vasque asymétrique		
↔ cm	Matt / Mate	Gloss / Brillo / Brillant
81	YSF/236	YSF/241
91	YSF/252	YSF/257
101	YSF/272	YSF/277
121	YSF/312	YSF/317
141	YSF/352	YSF/357

Rubi Clicker valve matte or gloss: 5SI7/050
Válvula Clicker Rubi mate ó brillo: 5SI7/050
 Clapet à Clicker Rubi mat ou brillant: 5SI7/050

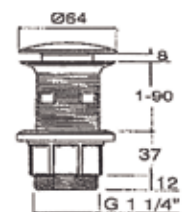

* INC. Cut back box or shape in matte finish: +50 UD.
***INC. Corte caja trasera o forma en acabado mate: +50 UD.**
 * INC. Découpe ou forme en finition mate: +50 UD.

* INC. Cut back box or shape in gloss finish: +80 UD.
***INC. Corte caja trasera o forma en acabado brillo: +80 UD.**
 * INC. Découpe ou forme en brillant: +80 UD.

INCREMENTOS GENERALES - PRODUCTO:

- Medidas fuera de tarifa Incremento de ancho, alto y fondo 10% cada 10 cm, en muebles, espejos y estructuras.
- Sistema taladro cremalleras en altos y bajos Incremento: +12 puntos unidad.
- Sistema taladro cremalleras en Columnas Incremento: +20 puntos unidad.
- Combinado color: Se considera combinado color, cuando en un modulo se combina 2 colores diferentes del mismo material. Incremento: +20 puntos.

GENERAL INCREMENTS - PRODUCT:

- Non-tariff measures Increase in width, height and depth 10% every 10 cm, in furniture, mirrors and structures.
- Drill system zippers in highs and lows Increment: +12 points unit.
- Drill system zippers in Columns Increment: +20 points unit.
- Combined color: It is considered combined color, when in a module 2 different colors of the same material are combined. Increase: +20 points.

INCREMENTS GENERAUX - PRODUIT:

- Mesures non tarifaires Augmentation de la largeur, de la hauteur et de la profondeur de 10% tous les 10 cm, des meubles, des miroirs et des structures.
- Fermetures à glissière du système de forage en haut et en bas Incrément: unité de +12 points.
- Fermetures à glissière du système de forage en incréments de colonnes: +20 points.
- Couleur combinée: elle est considérée comme une couleur combinée lorsque, dans un module, 2 couleurs différentes du même matériau sont combinées. Augmentation: +20 points.

Sergio Luppi

Debido a los procesos de impresión los colores que aparecen en este catálogo deben considerarse aproximados, no exactos.

Sergio Luppi, se reserva el derecho de introducir modificaciones, cambio de detalles, etc. que considere necesarios en beneficio del producto y del cliente.

Queda prohibido cualquier tipo de reproducción total o parcial de las imágenes, textos, ilustraciones y grafismos sin autorización expresa de Sergio Luppi.

Due to the printing processes the colors that appear in this catalogue should be considered approximate, not exact.

Sergio Luppi, reserves the right to make changes, technical improvements, etc. which it deems necessary for the benefit of the product and the purchaser.

Any type of partial or total reproduction of the images, texts, illustrations and graphics is prohibited without express authorization of Sergio Luppi.

Suite aux processus d'impression, les couleurs présentées dans ce catalogue sont approximatives.

Sergio Luppi se réserve le droit de réaliser des modifications, comme des changements de détails, etc. qu'il considère nécessaires afin de satisfaire le client.

Il est interdit de reproduire, de manière totale ou partielle, les images, les textes, les illustrations et graphismes sans autorisation de Sergio Luppi



Diseño y Maquetación:

CARLOS MARCO | TALLER DE LA IMAGEN



Sergio Luppi
beno

Sistemas modulares Sergio Luppi, S.L.
Poligono Tejerías, C/Rifondo 9
Calahorra - 26500 - La Rioja
Tel. +0034 941 14 50 86
Fax. +0034 941 14 50 99

e-mail. comercial@sergioluppi.es

www.sergioluppi.es